

EDD61 & EDD91

Extractors

Installation, Use and Maintenance



Important

The CDA Group Ltd cannot be held responsible for injuries or losses caused by incorrect use or installation of this product. Please note that CDA reserve the right to invalidate the guarantee supplied with this product following incorrect installation or misuse of the appliance or use in a commercial environment.

This appliance is not designed to be used by people (including children) with reduced physical, sensorial or mental capacity, or who lack experience or knowledge about it, unless they have had supervision or instructions on how to use the appliance by someone who is responsible for their safety.

Under no circumstances should any external covers be removed for servicing or maintenance except by suitably qualified personnel.

Appliance information:

Please enter the details on the appliance rating plate below for reference, to assist CDA Customer Care in the event of a fault with your appliance and to register your appliance for guarantee purposes.

Appliance Model	
-----------------	--

Serial Number	
---------------	--

CE Declarations of Conformity:

This appliance has been manufactured to the strictest standards and complies with all applicable legislation, including Gas safety, Electrical safety (LVD) and Electromagnetic interference compatibility (EMC).

IMPORTANT INFORMATION FOR CORRECT DISPOSAL OF THE PRODUCT IN ACCORDANCE WITH EC DIRECTIVE 2012/19/EU.

At the end of its working life, the product must be taken to a special local authority waste collection centre or to a dealer providing appliance recycling services.

Disposing of a household appliance separately avoids possible negative consequences for the environment and health. It also enables the constituent materials to be recovered, saving both energy and resources. As a reminder of the need to dispose of household appliances separately, the product is marked with a crossed-out wheeled dustbin.

Please note:

- Under no circumstances should the extractor be connected to any gas ventilation system, flue system or hot air ducting system.
- Do not vent the extractor into an attic or loft space.
- Only house the extractor in rooms with adequate ventilation. Remember that the extractor is powerful and whatever air is extracted needs to be replaced.
- Do not tile the extractor in. It should be removable for service or maintenance.
- You must be able to isolate the extractor from the mains electrical supply after installation.
- This extractor has been designed to be used in a room with a volume of less than 90m³.
- Steam cleaners must not be used when cleaning this appliance.

-
- The performance of your extractor will vary depending on a number of factors. These include: type of extraction, length of ducting, room volume, ventilation available and cleanliness of the filters.

Using Your Extractor

For best performance, you should switch on the extractor 15 minutes before starting to cook and leave it to run for approximately 15 minutes after the end of cooking.

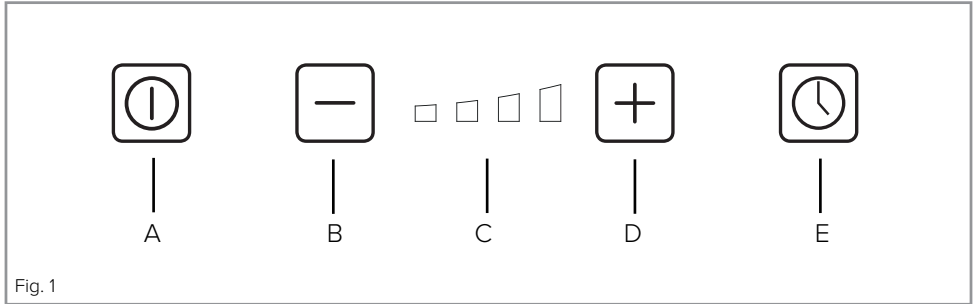



Fig. 1

Control Panel

- A - Off key
- B - “-” key
- C - Speed selection display
- D - On / “+” key
- E - Timer key

To switch on the extractor or to increase the speed at any time

- While the appliance is switched off, touch the “On/+” key  once to raise the extraction panel to its full height. The moving panel will raise to its operating position and the appliance will start to extract at its slowest speed once it reaches 180mm above its rest position.
- To increase the speed, wait until the extractor has reached its full height and is running at the first speed, then touch the “On/+” key  several times, until the desired speed is reached.
- The number of LED’s lit on the speed selection display corresponds to the speed setting number (e.g. 2 LED’s lit for the second speed).

To decrease the speed at any time

- Touch the “-” key  a few times, until the required speed is reached.

To switch off the extractor

- Touch the “Off” key : The moving panel will descend to its rest position and the appliance will continue extracting until its height drops below approx. 180mm, at which point the extraction will stop.

Timed operation

- While the extractor is operating, touching the “Timer” key  once will set it to run for a further ten minutes then automatically shut down. This feature is most useful when you finish cooking and need to leave the kitchen unattended.

Other features

- After approx. 30 hours of operation the speed selection display on the control panel will flash to signify that the grease filters are due for cleaning. After they are cleaned and replaced (page 8) press the “Timer” key  once to reset the grease filter alarm timer.
- After the appliance has been running for 4 hours since the last key touch, it will automatically shut down. This is not a fault and is a feature to save power in the event that the appliance has been forgotten.
- When the front panel is removed for cleaning, all the movement and extraction functions are locked for safety.
- If anything obstructs the closure of the moving panel it will automatically stop and return to its fully open position.

Energy saving feature

This extractor is fitted with an energy saving feature that automatically reduces the motor speed if it is left on the highest setting. When the motor speed is set to the fourth level, it will automatically switch to level three after six minutes of operation.

Care and Maintenance

IMPORTANT: DO NOT PERFORM MAINTENANCE OR CLEANING OF THE EXTRACTOR WITHOUT FIRST SWITCHING OFF THE ELECTRICITY SUPPLY.

Cleaning

You should use a non-abrasive cleaner. Any abrasive cleaner (including Cif) will scratch the surface and could erase the control panel markings.

You can clean your extractor effectively by simply using a dilute solution of water and mild detergent and drying to a shine with a clean cloth, for example the CDA E-Cloth.

Cleaning the grease filters

The grease filters should be kept clean to minimise the risk of fire. At least once a month you should remove and clean the grease filters with hot soapy water. You can also wash the grease filters in a dishwasher, ensuring that you place them in an upright position to prevent damage from other items in the dishwasher. After rinsing and drying, replace the filters.

To remove and replace the grease filters

- Touch the “On/+” key  so the moving panel raises to its full extent, then isolate the power supply so it stays raised.
- By pulling the two top corners of the front panel (Fig. 2) at the same time, it will be released and pivot toward you.
- The grease filters can then be pulled forward and out.
- Replacement is a reversal of the removal procedure.

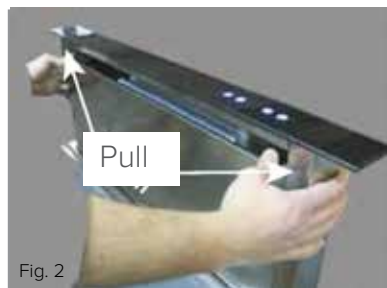

Please note:

Cleaning the grease filters in the dishwasher may lead to discolouration. This is normal and does not constitute a fault with the appliance.

Changing the charcoal filters (re-circulating only)

To ensure best performance of your extractor, you should replace the charcoal filters every four to six months, depending on use.

To replace the charcoal filters:

- Remove the grease filters as described above.
- The charcoal filters can then be lifted out and the replacements placed in position (as per upper image on page 9).
- Replace the grease filters (as per lower image on page 9).
- Lift the grease filter panel and close it back into place.

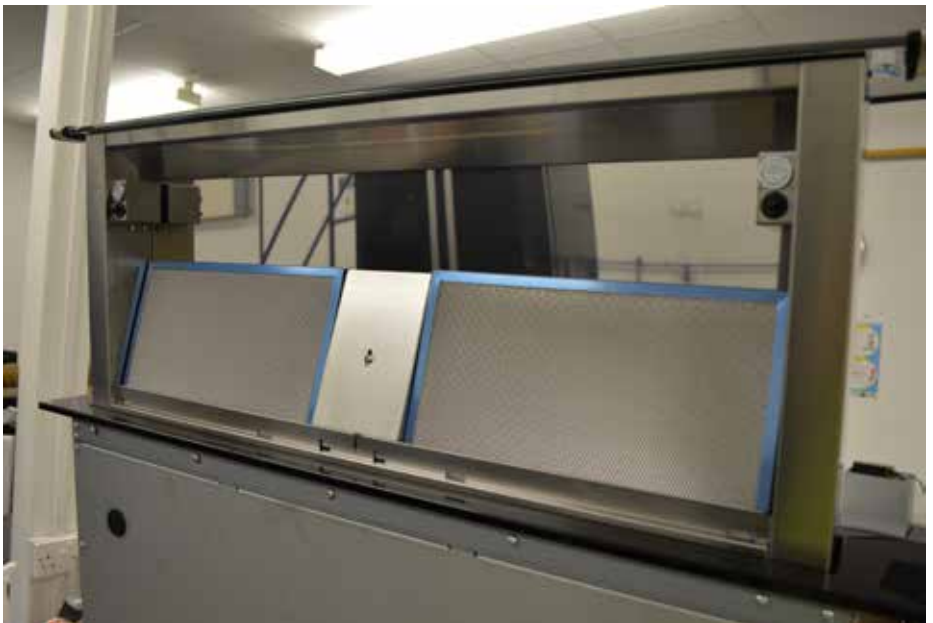

Mounting your Extractor

When the extractor is to be installed behind an electric or gas hob, the minimum distance between the hob and extractor must exceed 50mm. In the case of a gas hob, the minimum distance from any burner to the back of the hob must also be 65mm.

If the instructions provided with your gas hob state that the required distance between the hob and extractor must be greater than specified above, then that is the distance that should be observed; this is a legal requirement and may lead to your hob being disconnected from the gas supply and the installation being reported to RIDDOR.

IN THE ABSENCE OF ANY INSTRUCTIONS SUPPLIED WITH THE GAS HOB, THE MINIMUM DISTANCE BETWEEN THE HOB AND EXTRACTOR MUST BE AT LEAST 50mm.

The width of any hob must not be greater than the width of the extractor installed with it.

Ducting and Ventilation

- For best performance and lowest noise output, we recommend the use of 150mm ducting. Use of any smaller ducting will reduce performance and increase noise.
- The length of ducting should not exceed 5 metres in total.
- Limit the use of elbows in the ducting to a minimum: Bear in mind that each elbow imposes a similar restriction to flow to a 1 metre length of straight ducting.

- Avoid abrupt changes in direction for the ducting.
- Ensure that the ducting used satisfies all local and national standards applicable to the installation.

Troubleshooting

You observe that	Possible Causes	What should you do?
The hood does not work.	There is a power outage.	Check the power supply.
	The 9 pin connector is faulty or disconnected.	Check the orientation and security of the 9 pin connector.
	The internal breaker has tripped.	Press the red reset key on the electronic box.
The output is low.	The setting is insufficient for the fumes present.	Try a more powerful setting.
	Inadequate ventilation into the kitchen.	Ensure there is adequate facility for air intake to the kitchen.
	The charcoal filter (if fitted) is blocked.	Replace the charcoal filter.
	The exit ducting is obstructed.	Remove any obstructions from the ducting.
	The exit flaps on the motor housing are restricted.	Ensure the flaps rotate freely.
The hood stops in mid operation.	There is a power outage.	Check the power supply.
	The circuit breaker or fuse has tripped.	Check the circuit breaker or fuse.

In the event of a fault with the extractor, please contact CDA Customer Care for assistance:

A: Customer Care Department, The CDA Group Ltd, Harby Road,
Langar, Nottinghamshire, NG13 9HY

T: 01949 862 012 F: 01949 862 003 E: customer.care@cda.eu

Installation

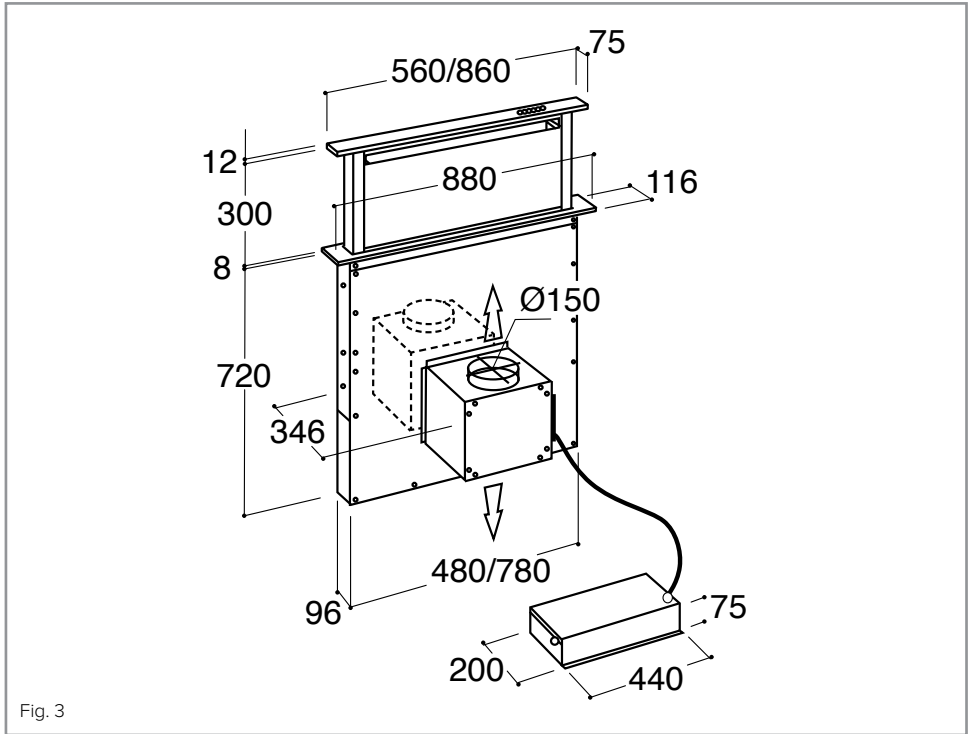

Note

- We recommend that you seek the help of another individual when installing this product.
- The fixings supplied are suitable for most installations. It is the responsibility of the installer to ensure that the fixings are suitable for the cabinets in the property.

Installation

- 1) Prior to installation, check that all parts are present and free from transit damage. In event of damage being discovered contact your supplier and do not proceed with installation.

2) Before making a cut-out in the kitchen cabinets or worktop, ensure that there are no structural (or other) obstructions that would hinder installation. Ensure that the cabinet dimensions are sufficient to accommodate the extractor, allowing for the specified clearance between the final installed positions of the extractor and the hob.

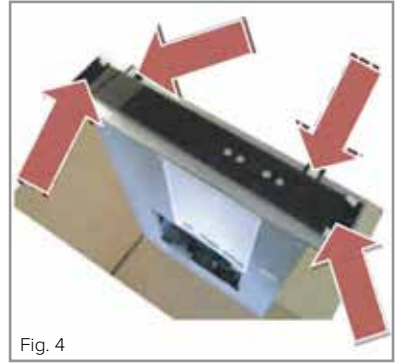

3) Before installation remove the transit pieces shown in fig. 4, 5, & 6.



4) Make a rectangular cut-out in the worktop to accommodate the extractor.
The dimensions of the cut-out should be:-

EDD61 - 490 x 100mm

EDD91 - 790 x 100mm

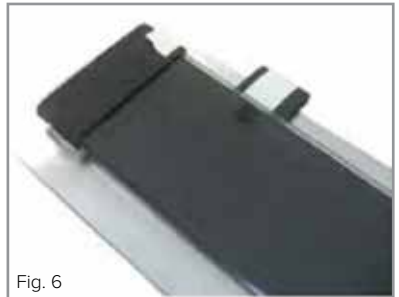

5) If your extractor has been supplied with the motor unit already mounted on the main body, this needs to be dismantled to enable the extractor to be inserted through the worktop cut-out.

6) Locate the support frame (trim piece); apply a narrow bead of silicone sealant to the underside of this (Fig. 7). Position this around the cut-out in the worktop (Fig. 8).



7) Lower the main body of the downdraft extractor through the support frame and into its fitted position.

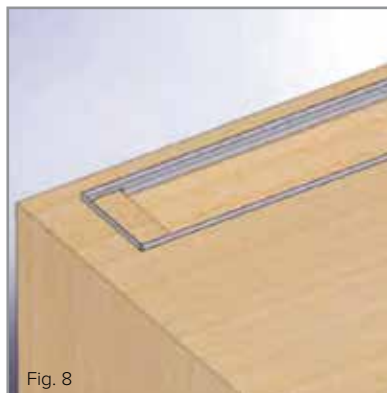

8) Fix the downdraft extractor inside the cabinet using the special fixing brackets supplied (Fig. 9).

- i) The brackets should first be attached to the extractor body in such a way that they leave a gap of approx. 2mm between the brackets and the base of the cabinet.
- ii) The screws fixing the brackets to the cabinet base are then used to pull the downdraft extractor firmly into its final installed position.

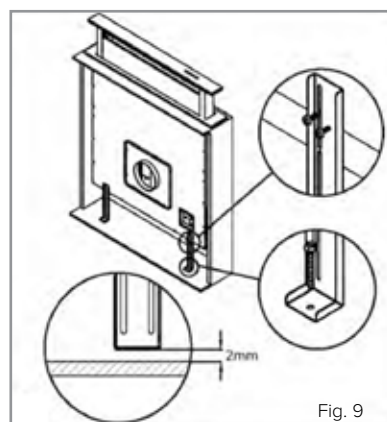

Note: Ensure that the downdraft extractor unit is vertical and perpendicular to the worktop before fitting the brackets to the cabinet base.

9) Refit the motor unit to the main body of the downdraft extractor. This may be positioned with the outlet facing vertically upward or downward.

10) Connect suitable ducting to the extractor outlet. See page 11 for ducting requirement details.

11) Position the metal box containing the electronic components in the cabinet, no closer than 65mm to any gas operated hob and no closer than 65mm to the extraction outlet.

We recommend installing the box containing the electronics at least 10cm above floor level and at a suitable distance from all sources of heat (e.g. oven sides, hob base).

12) Plug the 9 pin electrical connector from the electronic box into the downdraft body, being careful to orientate it correctly (Fig. 10).

13) Lift the downdraft moving panel and remove the door block (Figs. 11, 12 & 13).

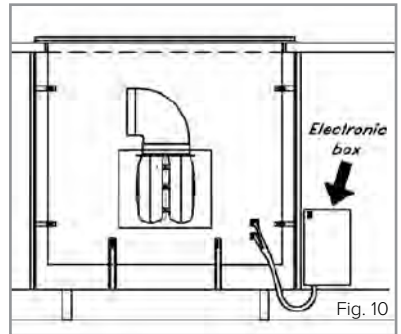

14) Open the filter cover (Figs. 14 & 15) then remove the grease filter package identified in Fig. 15.

15) Position the grease filters as shown in Fig. 16.



Downdraft Calibration

After installation it is necessary to calibrate the downdraft mechanism.

- Connect the power supply to the extractor.
- Touch the “On/+” key to start the moving panel rising.
- After the panel has risen by approx. 180mm touch the “Off” key to stop it from rising any further.
- Touch the “Timer” key once.
- After 2 seconds touch the “Off” key again.
- The LED’s on the control panel will flash to show that the downdraft extractor is carrying out its calibration procedure and the panel will raise/ lower.
- When the calibration procedure is complete the LED’s will stop flashing and the appliance may be operated normally.



Mains Electricity Connection

Warning! This appliance must be earthed.

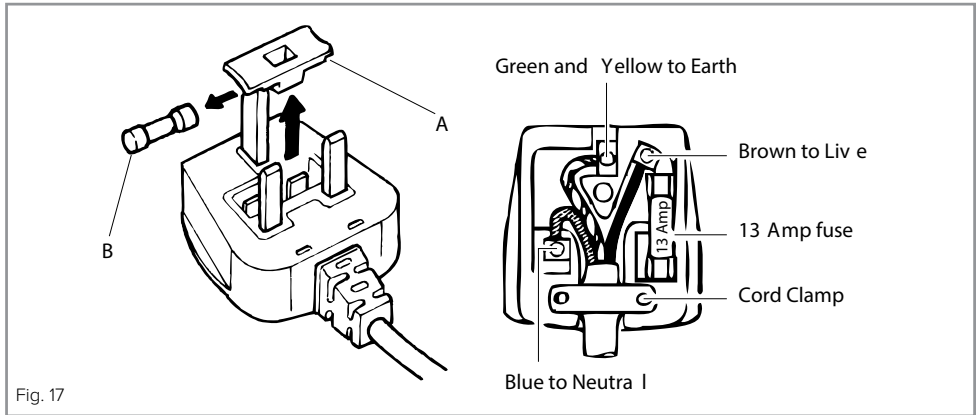

The mains lead of this appliance has been fitted with a BS 1363A 3Amp fused plug. To change a fuse in this type of plug, follow the steps below:

1. Remove the fuse cover and fuse.
2. Fit replacement 3A fuse, ASTA approved to BS 1362 type, into the fuse cover.
3. Replace fuse cover.

Important: Do not use the appliance without the fuse cover in position.

How to connect an alternative plug

If the fitted plug is not suitable for your socket outlet, then it should be cut off and disposed of safely to avoid possible shock hazard. A suitable alternative plug of at least 3 Amp rating to BS 1363 should be used.

As the colours of the wires in the mains lead of this appliance may not correspond with the coloured markings identifying the terminals in your plug, proceed as follows:-

- The wire which is coloured GREEN and YELLOW must be connected to the terminal which is marked with letter (E) or by the Earth symbol \perp or coloured GREEN and YELLOW.
- The wire which is coloured BLUE must be connected to the terminal which is marked with the letter (N) or coloured BLACK.
- The wire which is coloured BROWN must be connected to the terminal which is marked with the letter (L) or coloured RED.

If in doubt regarding the electrical connection of this appliance, consult a qualified electrician. Do not shorten the supply cable, the appliance may require removing for servicing.

N.B. Ensure that the plug socket is situated in an easily accessible place after installation.

Electrical Information

Mains electrical voltage: 240Vac.

Total rated power consumption: 200W

Energy Efficiency Information

Attribute	Symbol	Value		Units
Model identification		EDD61	EDD91	
Annual Energy Consumption	AEC_{Hood}	45.9	40.9	kWh
Time increase factor	f	1	0.8	
Fluid Dynamic Efficiency	FDE_{Hood}	28.1 (A)	32.7 (A)	
Energy Efficiency Index	EEI_{Hood}	54.4 (A)	44.3 (A)	
Measured airflow at Best Efficiency Point	Q_{BEP}	286.9	368.6	m ³ /h
Measured pressure at Best Efficiency Point	P_{BEP}	443	447	Pa
Maximum airflow	Q_{MAX}	636	757	m ³ /h
Measured electric power at Best Efficiency Point	W_{BEP}	125.7	140	W
Nominal lighting power	WL	0	14	W
Average illumination of the lighting system on the cooking surface	E_{Middle}	0	122	Lux
Measured power consumption in standby	P_S	0.49	0.49	W
Measured power consumption off mode	P_O	0	0	W
Sound power level	L_{WA}	69	61	dBA
Grease Filter Efficiency	GFE_{Hood}	61.1 (E)	63.0 (E)	%
Lamp Efficiency	LE_{Hood}	0	8.7 (E)	%

E & O E. All instructions, dimensions and illustrations are provided for guidance only. CDA reserve the right to change specifications without prior notice.



Please contact our **Customer Care Department** for Service on the details below

Customer Care Department

The ICDAI Group Ltd. • Harby Road • Langar • Nottinghamshire • NG13 9HY
T : 01949 862 012 F : 01949 862 003 E : customer.care@cda.eu

