



CI371 Washing Machine

Manual for Installation, Use and Maintenance

Contents

Contents	2
Important	3
Safety Warnings	4
Warnings	5
Recommendations	6
Before First Use	7
Control Panel.....	9
Opening the Door	10
Adding Detergents and Additives.....	11
Detergent Doses	12
Selecting the Washing Programme	13
Selecting and Confirming Options.....	14
Delay Timer	16
Starting the Wash Programme	17
The End of the Programme	18
Child Lock	20
Opening the Appliance in an Emergency	21
Programme Listing	22
Care and Maintenance.....	24
Practical Information.....	27
Troubleshooting	29
Installation	31
International Washing Signs	36

Important

The CDA Group Ltd cannot be held responsible for injuries or losses caused by incorrect use or installation of this product. Please note that CDA reserve the right to invalidate the guarantee supplied with this product following incorrect installation or misuse of the appliance or use in a commercial environment.

This appliance is not designed to be used by people (including children) with reduced physical, sensorial or mental capacity, or who lack experience or knowledge about it, unless they have had supervision or instructions on how to use the appliance by someone who is responsible for their safety.

Under no circumstances should any external covers be removed for servicing or maintenance except by suitably qualified personnel.

Appliance information:

Please enter the details on the appliance rating plate below for reference, to assist CDA Customer Care in the event of a fault with your appliance and to register your appliance for guarantee purposes.

Appliance Model	
-----------------	--

Serial Number	
---------------	--

This appliance has been manufactured to the strictest standards and complies with all applicable legislation, including Electrical safety (LVD) 2006/95/EC and Electromagnetic interference compatibility (EMC) 2004/108/EC.

IMPORTANT INFORMATION FOR CORRECT DISPOSAL OF THE PRODUCT IN ACCORDANCE WITH EC DIRECTIVE 2002/96/EC.

At the end of its working life, the product must not be disposed of as urban waste. It must be taken to a special local authority differentiated waste collection centre or to a dealer providing this service.

Disposing of a household appliance separately avoids possible negative consequences for the environment and health deriving from inappropriate disposal and enables the constituent materials to be recovered to obtain significant savings in energy and resources. As a reminder of the need to dispose of household appliances separately, the product is marked with a crossed-out wheeled dustbin. 

Safety Warnings

- If the plug or cord is damaged, do not connect the appliance to the mains power supply. If the cord is damaged it should be replaced by the manufacturer or appointed service agent in order to avoid a hazard.
- To remove the plug from the socket, pull on the body of the plug, not the cable.
- Do not plug the appliance in to the mains power supply with wet or damp hands.
- Never touch the appliance with wet hands or feet.
- Never open the detergent drawer when a programme is running.
- Never force the appliance door open when a programme is running.

- Since the appliance can reach high temperatures while running, do not touch the drain hose or drained water during draining.
- In case of any failure, first unplug the appliance and close the water tap.
- Repair on this appliance should only be undertaken by suitably qualified personnel.
- Keep the packing materials away from children to prevent risk of injury.
- Do not let children play with the washing machine.
- Keep pets away from the appliance.
- The appliance should not be installed on carpeted surfaces as this can block the air ventilation on the base.

Warnings

To avoid the risk of fire, electric shocks, injury or damage when using your washing machine, please take the following precautions:

- Please read all the instructions before using the washing machine.
- Do not wash items that have previously been cleaned, washed, soaked or treated with petrol, solvents for dry cleaning, other inflammable substances or explosives, as they produce fumes that could catch fire or explode.
- Do not add petrol, solvents for dry cleaning or other inflammable or explosive substances to the wash water as they produce fumes that could catch fire or explode.
- Do not repair or replace any part of the washing machine or try to carry out any type of servicing unless it is recommended in the maintenance instructions in the manual.
- Do not climb onto the machine or stand on the open porthole door.
- Do not use an extension lead or adaptor to connect your

washing machine to the mains supply.

- Follow the washing instructions recommended by the manufacturer of the garment to be washed.
- Do not turn your washing machine on until you are sure that it has been installed in accordance with the installation instructions and all the water, drainage, mains electricity and earth connections meet the local regulations and/or other applicable regulations.

Important: Ensure that the transit bolts have been removed prior to using the machine.

Recommendations

- Residues of detergent or softener left in the detergent drawer for long periods will dry and stick to the detergent drawer. To prevent this put the detergent and softener into the detergent drawer just before washing.
- It is recommended that the pre-wash programme should only be used for very dirty clothes.
- Do not exceed the maximum loading capacity.
- When the machine is not in use, keep the water tap closed.
- The appliance is not intended for use by people (including children) with reduced physical, sensory or mental capabilities, or lack of experience and knowledge, unless they have been given supervision or instruction concerning use of the appliance by a person responsible for their safety. Children should be supervised to ensure that they do not play with the appliance.
- If the appliance is not to be used for prolonged periods of time, unplug the appliance, close the water tap and leave the door ajar to keep the inside of the machine dry and to prevent unpleasant odours from developing.
- As a result of the quality control procedures during

production, a certain amount of water may remain in the appliance. This is normal and does not signify a fault.

- Do not remove the rating plate. The information on it is important.
- This appliance should not be installed in locations where the ambient temperature may fall below 0°C. Use in ambient temperatures below 0°C may damage the machine.

Before First Use

When your washing machine has been correctly installed, we recommend that you pre-clean the machine.

This is to check that the installation, the connections and the drainage are all correct, and to thoroughly clean the inside of the washing machine before any wash programmes are run.

Prior to pre-cleaning you should ensure the transit bolts have been removed.

- Select the Cotton 90°C programme and add a normal dose of detergent into the detergent dispenser.
- Press the Start/Pause button.

Preparing Garments for Washing

- Wash lightly soiled garments using a short programme.
- Use a programme without prewash for medium-soiled garments.
- Wash heavily soiled garments using a long programme with prewash.
- Wash white and coloured loads separately.
- We recommend that small garments are placed in a wash bag.
- We recommend using the delicate programmes for sensitive fabrics.
- Separate clothes according to their types (cotton, synthetic, sensitive, woolen, etc.), required washing temperatures and

level of dirtiness.

- Since new coloured clothes may shed dye on the first wash, wash them separately.
- Remove any metal pieces found on the items to be washed, for example curtain hooks.
- Fasten all zips and buttons.
- Turn garments, such as knitted fabrics, inside out.
- Before placing the clothes in the drum, make sure all the pockets are empty. Any small objects may block the drain pump.
- We recommend loading the washing machine to its full capacity for best water and energy efficiency.

Whenever possible, we recommend that you wash garments of different sizes within the same wash programme. This improves the washing action and also aids the correct distribution of the garments in the drum when spin-drying, and the washing machine will therefore be quieter.

Eco Note

The use of more detergent than necessary will not improve your washing results, and will have a negative effect on the environment.

We therefore recommend you follow the detergent manufacturer's instructions.

Control Panel

Display: shows the settings (spin speed, cycle status, timer, child lock on/off, maximum recommended weight). The settings can be modified using the buttons underneath.

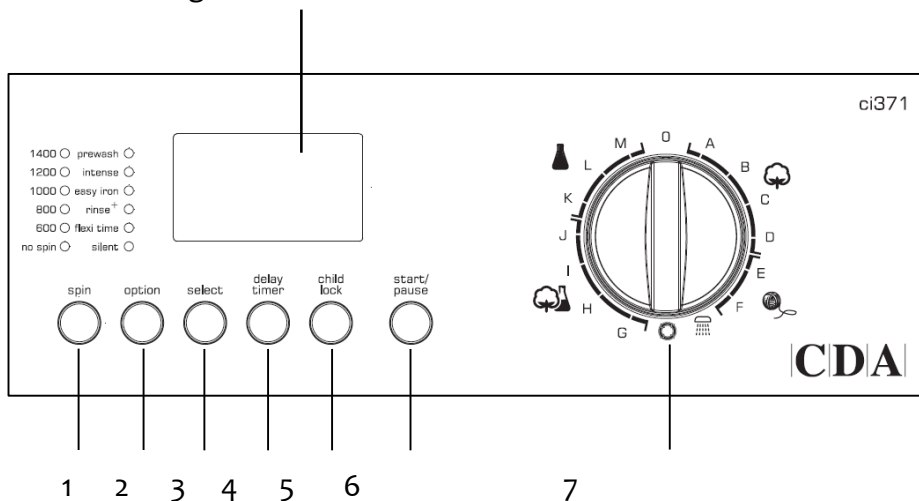

Buttons:

- 1: Spin speed selection
- 2: Choose option
- 3: Confirm option
- 4: Delay timer
- 5: Child lock
- 6: Start / Pause
- 7: Programme selector

Opening the Door

The appliance is fitted with a safety device which prevents the door from being opened while a programme is in progress.

Check that all the water has been drained from the tank and the drum is at a standstill.

Warning: If the washing programme is interrupted, it will be from 3 to 15 minutes before the door can be opened, depending on the temperature reached inside the appliance.

Loading the Washing Machine

- Open the door.
- Add the items to be washed separately, ensuring they are loaded evenly.
- When closing the door, ensure that no item is trapped between the door and the door seal.
- Close the door securely, otherwise the programme will not start.
- Subdivide the items for washing by fabric type and colour fastness.
- Wash white and coloured items separately. New coloured items should be washed separately the first time. Normally, items carry labels with washing instructions.

Adding Detergents and Additives

Your washing machine's detergent dispenser has three compartments, marked with symbols:

 For prewash detergent

 For main wash detergent

 For fabric conditioner, starch or other additives.

- The main wash detergent compartment has a tang allowing the use of liquid detergent. To insert it, pull it towards the front and then lower it, as shown here.
- Place the detergent and any additives in the drawer before the start of the programme.
- Never fill with liquids above the maximum level marked, otherwise the trays will empty too quickly.
- Before pouring concentrated fabric conditioners (or other dense additives) into the container, dilute with a little water to ensure they do not clog the outlet.
- Use only low-foam detergents suitable for use in a washing machine.
- The amount of detergent must be decided in relation to the hardness of the water, the type and quantity of items

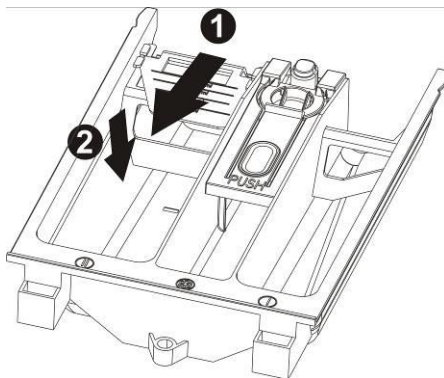

loaded, and their degree of soiling. This will provide the desired effect with optimal detergent consumption.

- On detergent packs the recommended dose is indicated for 4 levels of water hardness and for loads of 4-5 kg of washing with average dirt levels.

Detergent Doses

Laundry with normal dirt

- Choose a programme without prewash.
- Pour the total amount of detergent shown on the pack into the main wash compartment of the detergent drawer.

Very dirty laundry

- Choose a programme with prewash.
- Place $\frac{1}{4}$ of the recommended amount of detergent in the prewash compartment of the detergent drawer and $\frac{3}{4}$ of the detergent in the wash compartment.

Warning:

- For delicate items in synthetic fibre use from $\frac{1}{2}$ to $\frac{2}{3}$ of the recommended dose for washing tough cotton fabrics.
- Only neutral detergents recommended for wool should be used on the wool programme.
- Use the doses recommended by the detergent producer.

Liquid Detergent

- Pour the dose required into the measuring cap supplied with the bottle of liquid detergent and place it in the drum, or use the main wash compartment of the detergent drawer, fitting the insert provided.
- The scale on the red insert is intended as an aid when deciding the dose of liquid detergent.

Warning: Liquid detergents can be used, at the doses recommended by the manufacturer, only for the main wash, i.e. in all programmes without prewash.

Descalers

- Descalers can be added to the prewash and main wash compartments as recommended by their manufacturers.
- Place the detergent in the compartments first, followed by the descaler.

Selecting the Washing Programme

To switch on the appliance and select the programme, proceed as follows:

- 1 Turn the “Programme Selector” knob in either direction. This switches on the washing machine.
- 2 Select the washing programme. The time left to the end of the programme and the maximum recommended weight for the selected programme alternate on the display. The symbols on the display light up to identify the information shown.
- 3 The default spin speed values are shown. The initial settings can be modified using the button underneath the sequence of spin speeds.
- 4 If spin speed “no spin” is set, the appliance does not perform the final spin and the washing programme ends with water still in the tank.

Selecting and Confirming Options

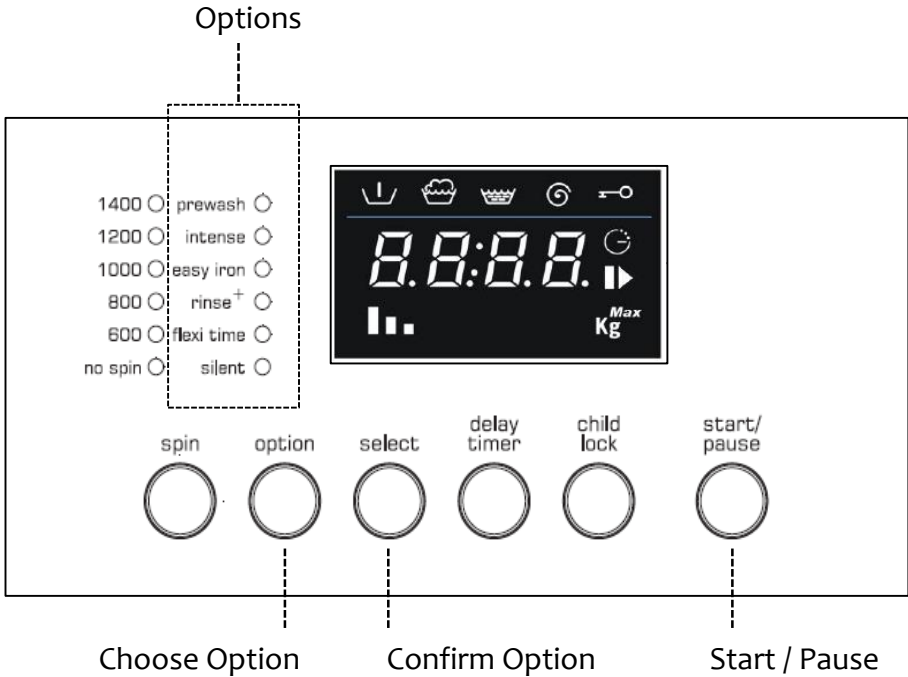

The “choose option” button can be used to choose the following options in sequence (from the top down):

Prewash: Adds a stage before the main wash, lasting about 20 minutes at a temperature of 35°C. This is suitable for loads of particularly dirty items.

Intensive: The max. temperature is changed to 60°C and the washing stage is extended to increase the effectiveness of the enzymes in the detergents. This is suitable for delicate but dirty items.

Easy iron: Produces items which are less creased and easy to iron.

Rinse +: Adds a rinse to the selected washing programme.

Flexi Time: Reduces the duration of the cycle. When selected (by pressing the “Confirm Option” button) the display shows one bar less and the cycle time will be reduced by up to 20%, depending on programme selected. With a second press of the “Confirm Option” button a further bar disappears from the display and the cycle time reduces by up to a further 15%, depending on programme selected. Pressing the “Confirm Option” button again returns the cycle time to its full duration.

Silent: Sets whether or not the buzzer will sound at the end of the cycle. The appliance comes with the buzzer function "On".

To confirm the chosen option, simply press the “Confirm Option” button and the LED of the option remains on.

To delete an option selection, simply return to the option with the “option choice” button and press the “Confirm Option” button. To cancel all the options previously selected in a single operation, simply hold down the “Confirm Option” button for 4 seconds.

The Buzzer option retains its "On" or "Off" status for subsequent cycles. It is only automatically switched to "Off" if the Night Wash programme is chosen.

Delay Timer

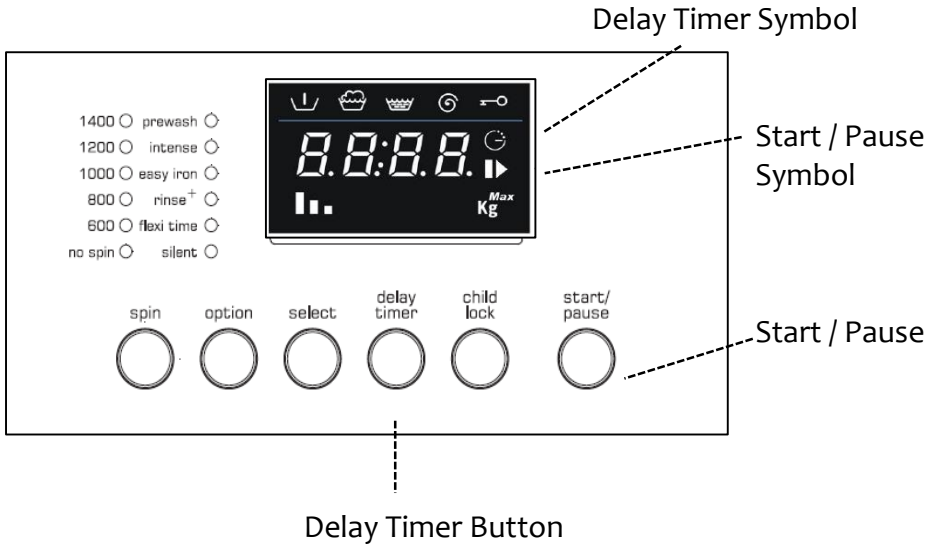

- 1 The “Delay Timer Button” can be pressed repeatedly to select the time after which the washing programme will end. The time left before the end of the cycle calculates the initial duration of the washing cycle, the settings made (temperature, spin speed and options) which may shorten or lengthen the cycle's initial duration, and the delay time the user wishes to add before the cycle starts.
- 2 After the Delay Timer function has been set, the symbol on the display remains on.
- 3 To cancel the Delay Timer function, keep pressing the button repeatedly until the display shows “0”.
- 4 The Start / Pause symbol flashes on and off until the cycle starts. After the cycle starts, the symbol remains constantly lit.

Starting the Wash Programme

- 1 To start the washing programme (after making the settings you want) press the “Start/Pause” button.
- 2 Once the cycle has started, the display shows the time remaining before the end of the cycle and the “Start/Pause” symbol on the display is constantly on.
- 3 During the washing/drying programme, the symbols which identify the various phases light up:

Cycle phase symbols:

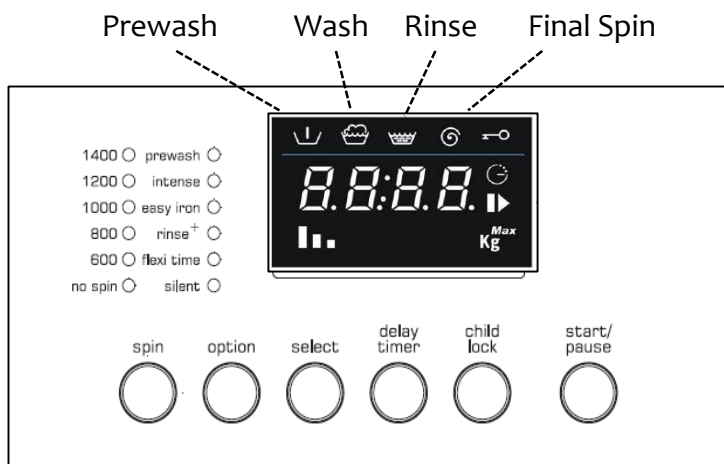

Stopping or Changing the Programme

The washing programme in progress can be interrupted at any stage:

- 1 Press the “Start / Pause” button for about 3 seconds: the display shows the word PAUS (for 1 second) alternating

- with the time remaining until the end of the cycle (for 1 second). The “Start / Pause” light flashes on and off.
- 2 Programmes can also be interrupted by turning the “Programme Selector” knob while the cycle is in progress.
 - 3 To change the washing programme, simply turn the “Programme Selector” to select the new programme; there is no need to set the appliance in pause status. The new cycle will be carried out completely, beginning from the start. If the tank had already been filled with water during the previous cycle, the water intake phase will be omitted from the new programme.
 - 4 To restart the cycle, press the “Start / Pause” button again.

The End of the Programme

Washing programmes are completed automatically. The word END appears on the display and the "Time Remaining" light goes out.

- 1 **Switch the appliance off by turning the “Programme Selector” knob to “OFF “**
- 2 Unload the laundry from the drum.
- 3 Leave the door ajar to allow the interior of the washing machine to dry out.
- 4 **Turn off the water intake tap.**

If during the initial spin speed setting stage, the "no spin" mode (spin speed set as “o”) was selected, at the end of the washing programme the word “STOP” appears on the display, alternating with “---“ (spin speed of “o”), the spin light stays on.

To proceed with the pump-out and spin, press the spin selection button twice. The appliance restarts the cycle with the pump-out and spin. To select the spin speed required, press the button until

the chosen speed is displayed. To pump out the water from the tank without performing the spin, press the spin selection button until the display indicates speed of 0: the pump-out will be run without spin.

Child Lock

When this function is activated, changing options, temperature, spin speed and the washing/drying cycle is not possible while the cycle is in progress.

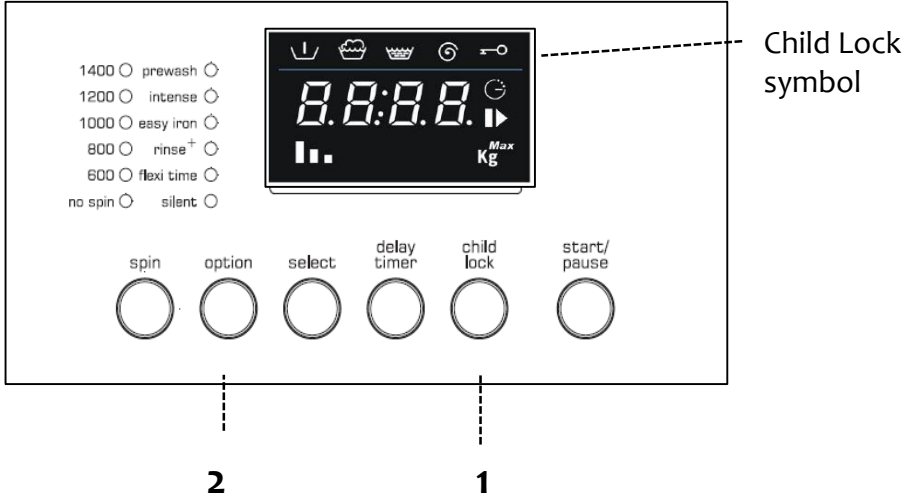

- 1 To activate the “Child Lock” function, press the “Child Lock” (1) button and hold it down. Also press the “Choose Options” (2) button within 3 seconds.
- 2 The “Child Lock” symbol lights up to show that the function has been activated.
- 3 Repeat the same procedure to deactivate the function.

Opening the Appliance in an Emergency

In the event of a power failure, the door can be opened using the mechanical release, activated by means of the lever in the bottom of the appliance:

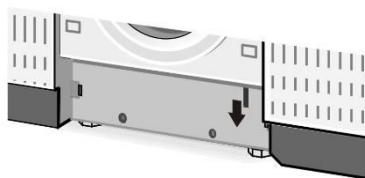









- 1 Turn the “Program Selector” knob to “Off” and disconnect the power supply plug from the socket.
- 2 Drain off the water (see page 25)
- 3 Pull the lever down and open the door.



Warning: Scalding hazard: before opening the door, check that the appliance does not contain boiling hot water and detergent which may pour out and cause injury when the door is opened.

Warning: Do not open the door using the emergency release lever while the drum is turning.

Programme Listing

Programmes	Symbol	Temp. (°C)	Max. Spin (rpm)	Max. Load (kg)	Options				
					Prewash	Intense	Easy Iron	Rinse ⁺	FlexiTime
Cottons 	A	CoH	Max	7	✓	✓	✓	✓	✓
	B	40°	Max	7	✓		✓	✓	✓
	C	60°	Max	7	✓		✓	✓	✓
	D	90°	Max	7	✓	✓	✓	✓	✓
Wool 	E	CoH	800	2					
	F	30°	800	2					
Rinse		—	Max	7			✓		✓
Spin		—	Max	7			✓		✓
Handwash		G	CoH	800	2				
Delicate / Silk		H	20°	600	2		✓		✓
Rapid 15'		I	30°	800	2				
Mix 30°		J	30°	1200	3	✓	✓	✓	✓
Synthetics 	K	40°	1000	3.5	✓	✓		✓	✓
	L	30°	1000	3.5	✓	✓		✓	✓
	M	CoH	1000	3.5	✓	✓		✓	✓

✓: Option available

Detergent Compartments			Load Types	Programme Descriptions
 Pre-wash	 Wash	 Conditioner		
✓	✓	✓	Delicate coloureds w in light dit	Cold wash, rinses and final spin at the selected speed
✓	✓	✓	Delicate coloureds w in norm al dit	W ash at 40°C, rinses and final spin at the selected speed (standard cycle w ithout any option selected)
✓	✓	✓	Tough coloureds w in norm al dit	W ash at 60°C, rinses and final spin at the selected speed (standard cycle w ithout any option selected)
✓	✓	✓	Tough coloureds w in heavy dit	W ash at 90°C, rinses and final spin at the selected speed
	✓	✓	Wool and silk	Cold wash, rinses and final spin at the selected speed
	✓	✓	Wool and silk	W ash at 30°C, rinses and final spin at the selected speed
		✓		Rinse and pump-out only, or pump-out and final spin at the selected speed
				Pump-out only, or pump-out and final spin at the selected speed
	✓	✓	Items for refreshing	Cold wash, rinses and final spin at the selected speed
	✓	✓	Items w in light dit	W ash at 20°C, rinses and final spin at the selected speed
	✓	✓	Light cotton or delicate fabrics for refreshing	W ash at 30°C, rinses and final spin at the selected speed
✓	✓	✓	Cotton and synthetics w in light dit	W ash at 30°C, rinses and final spin at the selected speed
✓	✓	✓	Items w in norm al dit	W ash at 40°C, rinses and final spin at the selected speed
✓	✓	✓	Items w in light dit	W ash at 30°C, rinses and final spin at the selected speed
✓	✓	✓	Items for refreshing	Cold wash, rinses and final spin at the selected speed

Care and Maintenance

Before beginning any care or maintenance, you should always disconnect the appliance from the electricity supply, and also turn off the water supply.

If a programme has been run recently, wait for the water in the appliance to cool down to prevent risk of scalding.

Cleaning the Outside of the Appliance

- Regular, thorough cleaning will keep your appliance looking good.
- Clean the exterior of the appliance with soap and water only, then dry thoroughly with a soft cloth.
- The plastic parts should just be wiped with a damp cloth.
- Do not scrape with pointed objects, or use solvents or products containing abrasive substances (including Cif) because they damage the surfaces.
- **For reasons of safety, never spray the washing machine with jets of water.**

Cleaning the Drum

- Remove any rust marks from the drum using a stainless steel cleaner.
- For descaling the washing machine use only brand-name descalers which contain an anti-corrosion agent for washing machines.
- Always follow the producer's instructions with regard to use and dosages.
- **After descaling or removing rust from the drum, carry out a few rinse cycles to remove all acid residues which might damage the appliance. Never use cleaners which contain**

solvents. There is the risk of the formation of vapours which might catch fire and explode.

Cleaning the Door Seal

Check regularly that there are no paper clips, buttons, nails or pins in the folds of the door gasket.

Cleaning the Drain Pump

The drain pump only needs cleaning if the water is not being pumped out efficiently. This may happen if it has been blocked by buttons, brooches or similar objects.

In this case, proceed as described below.

Remove the mains plug to disconnect the appliance from the electricity supply.

- Use a small screwdriver as a lever to remove the plugs shown here, turn the plinth downwards to access the pump

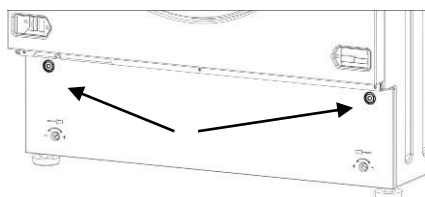

- Extract the drain hose "A".

Warning: if the hose is hot, the water is hot or could be near boiling point.

- Place a shallow container on the floor and remove the plug "B" to drain off the water.
- Depending on the amount of water in the appliance, the container may have to be emptied several times.

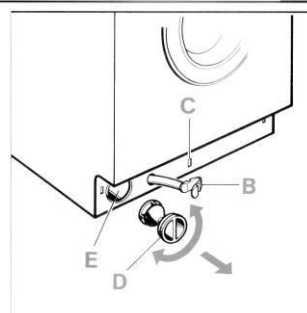
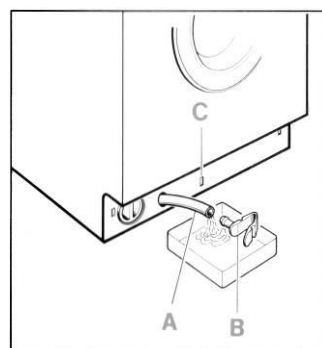

- When no more water is coming out, close the hose again by pushing the plug “B” firmly back into place.
- Unscrew the cover of the pump “D” by turning it anticlockwise.
- Clean the pump and remove any foreign bodies.
- Also check the inside “E”, making sure that the impeller turns freely; any foreign bodies stuck in it must be removed.
- Screw the cover back on the pump.
- Secure the drain house by snapping the plug back into place “C”.
- Fit the bottom of the plinth first. Push it towards the cabinet and put the plugs back into place.

Cleaning the Detergent Drawer

The detergent drawer should be kept clean, removing all solid deposits.

To simplify this operation, completely remove the detergent drawer:

- Pull the drawer fully out, press in the zone marked “PUSH” and then remove completely.
- Remove the syphon "A" and clean all parts with hot water.
- Fully re-insert the syphon and remove any detergent deposits before putting the drawer back in position.

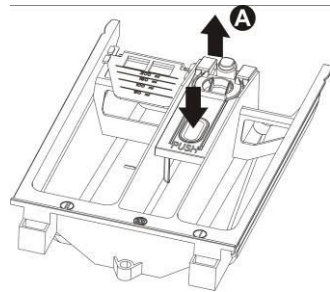

Water intake filters

There are filters on the tap side of the water inlet hose and at the ends of the water inlet valves. These filters prevent ingress of dirt or foreign objects into the machine through the water supply. These filters should be cleaned approximately once a year to ensure there is no interruption in the water supply to the machine.

- Remove the water inlet hose.
- Remove the filters on the water inlet valves using pliers.
- Remove the filters on the tap side of the water inlet hose manually, as well as the seal.
- Clean the filters thoroughly using a brush.
- Replace the filters carefully, in the same way as they were removed.

Practical Information

Alcoholic Beverages: The stain should first be washed with cold water, then wiped with glycerine and water and be rinsed with water mixed with vinegar.

Shoe Polish: The stain should be slightly scratched without ruining the cloth, rubbed with detergent and rinsed. In case it is not eliminated, it should be rubbed with 1 unit of pure alcohol (96 degrees) mixed in 2 units of water and then washed with lukewarm water.

Tea and Coffee: Stretch the stained area of your cloth on the top of a container and pour water as hot as the type of cloth can endure. If the type of cloth is suitable, wash it with lye.

Chocolate and Cocoa: By leaving your clothes in cold water and rubbing with soap or detergent, wash it in the highest temperature that the type of cloth can endure. If there is still a stain left, wipe with oxygenated water (in proportion of 3%).

Tomato Paste: After scraping the dried pieces without ruining the cloth, leave in cold water for about 30 minutes and wash by rubbing with detergent.

Meat/Soup/Egg: Eliminate the dried stain residues and wipe with a sponge or soft cloth dampened with cold water. Rub with detergent and wash with diluted washing soda.

Grease and Oil Stains: First wipe the residues. Rub the stain with detergent and then wash with lukewarm soapy water.

Mustard: First apply glycerine to the stained area. Rub with detergent and then wash. If the stain still does not disappear, wipe with alcohol (On synthetic and coloured cloth, a mixture of 1 unit alcohol, 2 units water should be used).

Blood Stain: Lay your clothes in cold water for 30 minutes. If the stain still does not disappear, lay in mixture of water and ammonia (3 table-spoons of ammonia in 4 litres of water) for 30 minutes.

Cream, Ice-Cream and Milk: Lay your clothes in cold water and rub the stained area with detergent. If the stain has still not disappeared, wash with diluted washing soda. (Do not use washing soda on coloured clothes.)

Mould: Mould stains should be cleaned as soon as possible. The stain should be washed with detergent, and if it does not disappear, it should be wiped with oxygenated water (in proportion of 3%).

Ink: Hold the stained area under cold water and wait until the inky water completely runs off. Then rub with lemon juice and detergent diluted in water, wash after waiting for 5 minutes.

Fruit: Stretch the stained area of your clothes on the top of a container and pour cold water on it. Do not pour hot water on the stain. Wipe with cold water and apply glycerine. Wait for 1-2 hours and rinse after wiping with a few drops of white vinegar.

Grass stain: Rub the stained part with detergent. If the type of fabric is suitable for use of washing soda, you can add it into your washing water. Rub your woollen clothes with alcohol. (For colour, use a mixture of 1 unit pure alcohol and 2 units of water).





Oil Paint: The stain should be eliminated before it dries by applying thinner on it. Then it should be rubbed with detergent and washed.

Burnt Stain: If your cloth is suitable for use of washing soda, you can add it into your washing water. For woollens, a cloth damped in oxygenated water should be covered on the stain and it should be ironed with a dry cloth on it. It should be washed after rinsing well.

Troubleshooting

Error Display

In event of a malfunction the machine will identify the problem by showing an error code on the display

Error Code	Suggested Action
	Door not closed properly: Try reclosing it.
	Aqua stop device tripped: Cut off power supply, turn off water tap and contact CDA Customer Care.
	Water not taken in for washing: See troubleshooting table below.
	Water not pumped out: See troubleshooting table below.

Troubleshooting Table

Below is a list of some of the possible malfunctions.

If the problem cannot be resolved as described, contact Customer Services.

Problem	Suggested Checks
Appliance does not start	Plug is properly connected to socket Door is securely closed "Start/Pause" button has been pressed
Water not filling	Plug is properly connected to socket Door is securely closed Water tap is turned on Water intake hose filters not blocked Water intake hose not trapped or kinked
No water visible in washing drum	Not a fault The water level should be below the bottom of the glass
Water not pumped out	Drain hose not kinked Drain pump not blocked
Water not pumped out after last rinse in delicate fabrics and wool wash programmes	Not a fault A pause is programmed into washing programme to prevent creasing of fabrics To pump out water, proceed as described in "The End of the Programme", p18
Water enters and pumps out continuously	The end of drain hose is too low down
Strong vibrations during spins	Appliance is properly levelled Appliance is not too close to walls or cupboards Transit bolts not removed, or drum otherwise locked in position
Excessive foam in drum, flowing out of drawer	Detergent used is recommended for automatic washing machines and not for hand washing Quantity of detergent used is as stated in manual and no more
Water on floor	Water intake hose fittings not loose End of drain hose still correctly positioned

Not all fabric conditioner used or too much water left in compartment

The detergent drawer syphons are correctly fitted and not blocked

Installation

Transit bolts and plastic spacers, located at the rear of the appliance, must be removed prior to using the appliance to prevent damage.

- Loosen the transit bolts using a 10mm spanner by turning them anticlockwise and then remove them.
- Remove the plastic spacer secured by each transit bolt.
- Fit the plastic blanking plugs (supplied) to seal the bolt holes against water ingress.

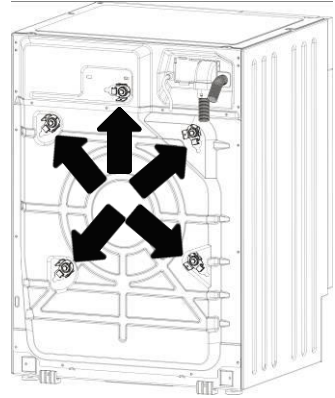

Warning: Do not turn the machine upside down or lie it on its side.

Do not throw the transit bolts or plastic spacers away.

If you need to move the washing machine after installation you should first replace the transit bolts.

Do not install your machine on rugs or similar surfaces.

For your machine to work silently and without any vibration, it should be installed on a flat, non-slippery and solid surface.

Never put cartons, wooden blocks or similar materials under the machine to level the surface under the appliance

Leveling

1. On appliances with adjustable rear feet, note that the rear of the appliance (as supplied) rests on skids and not on the feet.
2. Before positioning the washing machine, check that the rear feet are screwed fully in, to prevent damage as the appliance is shifted into position.

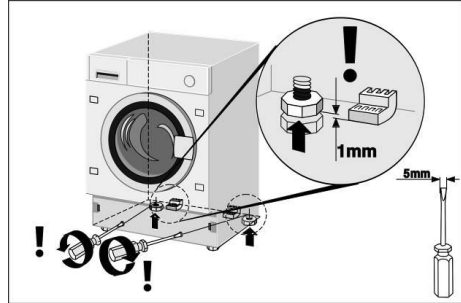

3. Once the appliance is in its position, the height of the rear feet has to be increased so that the appliance no longer stands on the skids.

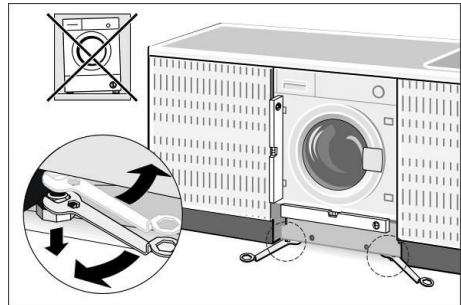

4. After adjusting the rear feet, level the appliance by adjusting the front feet to suit. The front feet should be locked in position by securing the locknuts tightly against the underside of the washing machine.

Note: Raising the washing machine too high can affect the stability of the appliance.

Connecting to the Mains Water Supply

1. Check that the water supply pressure is in the range: 0.1-1.0MPa. With higher pressures, use a pressure reducer.
2. Connect the cold water supply hose (blue screw collar) to the cold water tap with $\frac{3}{4}$ " gas threaded connector, taking care to tighten firmly to prevent leaks. The water supply hose must not be kinked or crushed and must not be changed or cut. Threaded connections must only be tightened by hand.

Warning:

- If the connection is made to new pipelines, or lines which have been out of use for a long time, allow a considerable amount of water to flow out before connecting the intake hose. This prevents any grit or other dirt from fouling the filters installed in the appliance to protect the water intake valves.
- The new intake hose supplied with the appliance must be used, and the old water supply hose must not be used.

Drainage Connection

- It is recommended that you have a fixed drainage outlet 60 to 70cm from the floor.
- Avoid the drain hose being too tight, kinked or restricted.
- The water outlet can either be connected to a water drain or to a sink outlet spigot. This connection should be a minimum of 60cm and a maximum of 100cm

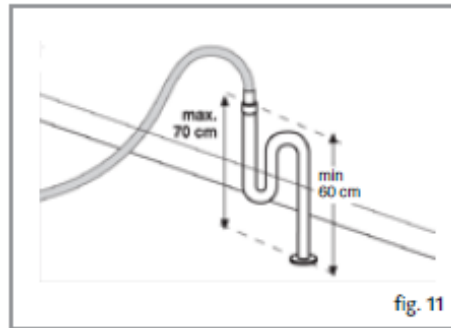

from the floor.

- The drain hose should be no longer than 4m in length to ensure good performance from the washing machine.
- After connecting the water supply, check to ensure there are no leaks.

The drain hose must be securely fastened to the outlet to prevent any risk of the drain hose becoming detached and causing flooding.

Once the appliance is connected to the water supply and the drain connection, ensure that the water inlet and drain hoses are not folded, twisted, crushed or elongated by stretching when moving the appliance into position.

Electrical Information

Warning! This appliance must be earthed.

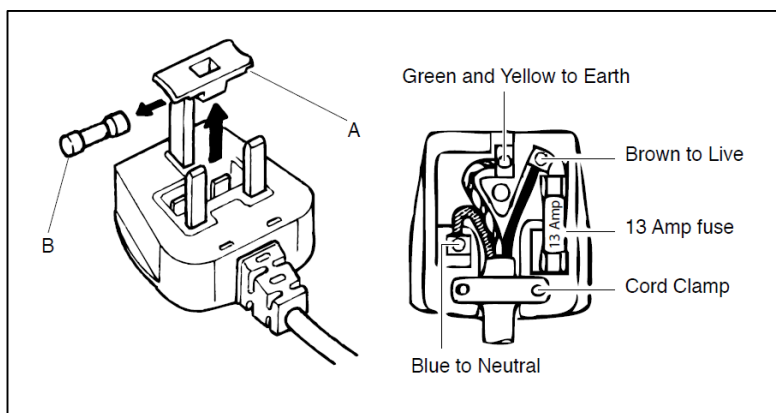

The mains lead of this appliance has been fitted with a BS 1363A 13 Amp fused plug. To change a fuse in this type of plug, follow the steps below:

1. Remove the fuse cover and fuse.
2. Fit replacement 13A fuse, ASTA approved to BS 1362 type, into the fuse cover.
3. Replace fuse cover.

Important: Do not use the appliance without the fuse cover in position.

How to Connect an Alternative Plug

If the fitted plug is not suitable for your socket outlet, then it should be cut off and disposed of safely to prevent the risk of electric shock. A suitable alternative plug of at least 13 Amp rating to BS 1363 should be used.





As the colours of the wires in the mains lead of this appliance may not correspond with the coloured markings identifying the terminals in your plug, proceed as follows:-





- The wire which is coloured **GREEN** and **YELLOW** must be connected to the terminal which is marked with letter **(E)** or by the Earth symbol \perp or coloured **GREEN** and **YELLOW**.
- The wire which is coloured **BLUE** must be connected to the terminal which is marked with the letter **(N)**, or coloured **BLACK**.
- The wire which is coloured **BROWN** must be connected to the terminal which is marked with the letter **(L)** or coloured **RED**.





If in doubt regarding the electrical connection of this appliance, consult a qualified electrician. Do not shorten the supply cable, the appliance may require removing for servicing.



N.B. Ensure that the plug socket is situated in an easily accessible place.

International Washing Signs

			
Washing temperature	Do not wash in a washing machine	Lukewarm iron	Medium hot iron

			
Hot iron	Do not iron	Do not tumble dry	Hang to dry

			
Drip dry	Dry flat	Do not bleach	Handy to bleach

		
<p>All of these are dry cleaning symbols. The letters are to instruct the cleaner what type of solvent to be used. Garments bearing these symbols should not be washed in your machine unless the label says otherwise.</p>		

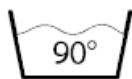

Wash up to 90 °C

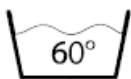

Wash up to 60 °C

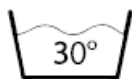

Wash up to 30 °C



Do not wash in a washing machine

NOTES

NOTES

NOTES



Please contact our Customer Care Department for Service on the details below

Customer Care Department • The CDA Group Ltd. • Harby Road • Langar • Nottinghamshire • NG13 9HY
T: 01949 862 012 F: 01949 862 003 E: service@cda.eu W: www.cda.eu