



hc3620 Built-In Ceramic Hob

Manual for Installation, Use and Maintenance

Contents

- Contents.....2
- Important.....3
- Important Note5
- Using Your Hob5
- Using the Timer 10
- Efficient Use of Your Hob.....13
- Care and Maintenance..... 15
- Troubleshooting..... 16
- Electricity Supply to the Hob.....17
- Fitting the Hob 19
- How to Install the Hob..... 21

Important

The CDA Group Ltd cannot be held responsible for injuries or losses caused by incorrect use or installation of this product. Please note that CDA reserve the right to invalidate the guarantee supplied with this product following incorrect installation or misuse of the appliance or use in a commercial environment.

This appliance is not designed to be used by people (including children) with reduced physical, sensorial or mental capacity, or who lack experience or knowledge about it, unless they have had supervision or instructions on how to use the appliance by someone who is responsible for their safety.

Under no circumstances should any external covers be removed for servicing or maintenance except by suitably qualified personnel.

Appliance Information:

Please enter the details on the appliance rating plate below for reference, to assist CDA Customer Care in the event of a fault with your appliance and to register your appliance for guarantee purposes.

Appliance Model	<input type="text"/>
-----------------	----------------------

Serial Number	<input type="text"/>
---------------	----------------------

This appliance has been manufactured to the strictest standards and complies with all applicable legislation, including Electrical safety (LVD) 2006/95/EC and Electromagnetic interference compatibility (EMC) 2004/108/EC. Parts intended to come into contact with food conform to 89/109/EC.

IMPORTANT INFORMATION FOR CORRECT DISPOSAL OF THE PRODUCT IN ACCORDANCE WITH EC DIRECTIVE 2002/96/EC.

At the end of its working life, the product must be taken to a special local authority waste collection center or to a dealer providing appliance recycling services.

Disposing of a household appliance separately avoids possible negative consequences for the environment and health. It also enables the constituent materials to be recovered, saving both energy and resources. As a reminder of the need to dispose of household appliances separately, the product is marked with a crossed-out wheeled dustbin.

Please Note:

- Ceramic hobs become hot and remain hot during and immediately after use. Do not touch the hob until it has been allowed to cool.
- Keep children away from the appliance when in use.
- Never put cooking foil or plastic materials on the ceramic surface when the hob is hot. These materials could melt and cause damage to the hob.
- Never use the hob top for storage.
- Pan handles should never stand out beyond the edge of the worktop. This will ensure children cannot reach them.
- Do not use pans with rough bases (e.g. cast iron) as these may scratch the hob surface.
- Do not switch on the zones without cookware in place.
- Do not lean over the hob when it is in use.
- Follow the cleaning instructions carefully.
- Ensure the base of the saucepan is clean and dry before placing it on the hob.
- After use, please ensure that all the zones have been switched off.
- This hob (Class 3) has been designed for use only as a cooking appliance. Any other use (e.g. heating rooms) should be considered incorrect and therefore dangerous.

- The appliance is not intended to be operated by any means of an external timer or separate remote-control system.

Important Note

Do not use the hob if the glass surface is cracked or damaged to prevent risk of electric shock. Disconnect it from the power supply.

Using Your Hob

Zones:

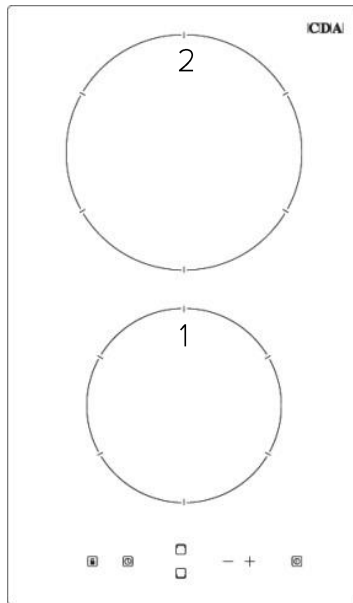

1. Front 1.2 kW
2. Back 1.8 kW

Control Panel:

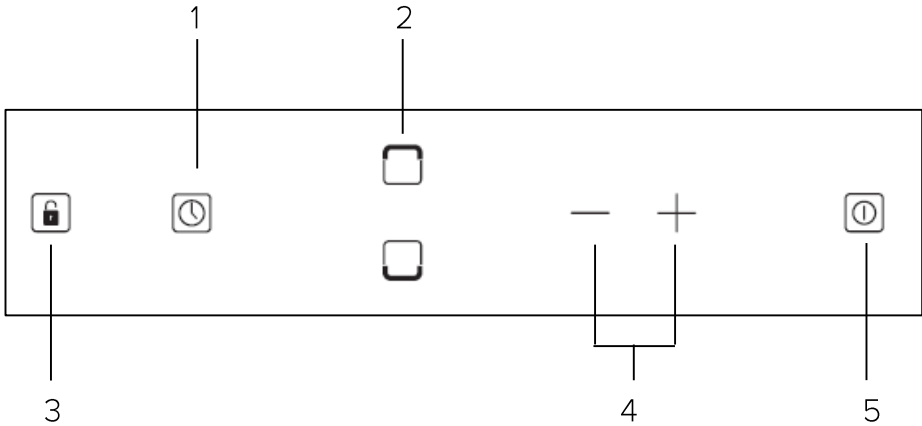

1. Timer Control
2. Heating zone selection controls
3. Key lock control
4. Power / Timer adjusting controls
5. ON/OFF control

Using the Touch Controls

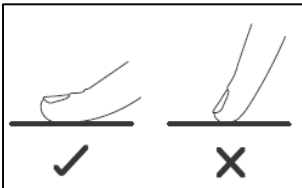

The controls respond to touch, so you don't need to apply any pressure.

Use the ball of your finger, not its tip.

You will hear a beep each time a touch is registered.

Make sure the controls are always clean, dry, and that there is nothing (e.g. a utensil or a cloth) covering them. Even a thin film of water may make the controls difficult to operate.

To Switch Heating Zones On



When the mains power supply is switched on, the buzzer beeps once and all the indicators light up for 1 second, then go out. This indicates that the ceramic hob has entered standby mode.

Touch the ON/OFF  control, all the indicators show “-“.

Place a suitable pan on the cooking zone that you wish to use (see “Efficient Use of Your Hob” section for selection of suitable pans).

Ensure the bottom of the pan and the surface of the cooking zone are clean and dry.

Touch the heating zone selection control that corresponds to the zone where the pan is placed (for example back .

Select a heat setting by touching the  or  controls. You may select any power level from “1” to “9”.

If you don't choose a heat setting within approx. 1 minute, the ceramic hob will automatically switch off.

You can change the heat setting at any time during cooking.



By holding down either of these controls, the power level will adjust up or down.



To use more than one heating zone, just touch the control for the next one you want to use, then select the power level for that (as above).

To Switch Heating Zones Off

Touch the heating zone selection control that corresponds to the

zone you wish to switch off (for example back .

Turn the cooking zone off by using the  or  controls to scroll down to “0”.

Alternatively, the zone may be switched off by touching the  and  controls together.

To switch all heating zones off at once it is only necessary to touch the ON/OFF  control.

Hot Hob Warning Indicators

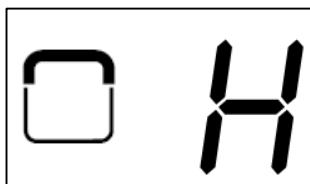

When a heating zone is hot, the indicator adjacent to that zone's corresponding selection control will show “H”

The hot hob warning indicators remain lit (even when the hob is switched off to standby mode) until the cooking zones cool sufficiently to touch.

Do not touch the glass plate until the indicator goes out.

Locking the Controls

You can lock the controls to prevent unintended use (for example children accidentally turning the cooking zones on).

When the controls are locked, all the controls except the ON/OFF  control are disabled.

To Lock the Controls:

Touch the key lock control . The timer indicator will show “Lo”.

To Unlock the Controls:

Touch and hold the key lock control  for approx. 2 seconds.

The controls are now unlocked and the ceramic hob is ready for use.

Warning: If the hob is switched off using the “ON/OFF” control  while the controls are locked, it will be necessary to unlock the hob using the process above BEFORE the hob is next switched on.

Over-Temperature Protection

The ceramic hob is fitted with a sensor to monitor the temperature inside the hob. When an excessive temperature is recorded, the ceramic hob will stop operation automatically.

Auto-Shutdown

The ceramic hob is fitted with an auto-shutdown safety feature.

If a cooking zone is accidentally left switched on for a long period it will automatically switch off after a default shutdown time.

The default shutdown times are dependent on power setting as shown here:

Power Level	1	2	3	4	5	6	7	8	9
Shutdown Time (hours)	8	8	8	4	4	4	2	2	2

Using the Timer

You can use the timer in two different ways:

- You can use it as a minute minder. In this case, the timer will not turn any cooking zone off when the set time is up.
- You can set it to turn one or more cooking zone(s) off after the set time.



You can set the timer for up to 99 minutes.



Using the Timer as a Minute Minder



Make sure the ceramic hob is switched on.

Note: you can use the minute minder even if you're not using any cooking zones.

Touch the timer control , the timer indicator shows "--"

Adjust the time setting by touching the  and  controls. The minute minder indicator will start flashing and will show in the timer display.

Touch the  or  control of the timer once to increase or decrease by 1 minute.

Touch and hold the  or  control of the timer to decrease or increase in 10 minute increments.

If the setting time exceeds 99 minutes the timer will automatically return to 0 minutes.

When the timer is set, it will begin to count down immediately. The display will show the remaining time.

When the set time is reached the buzzer beeps for up to 30 seconds and the timer indicator shows "--".

To cancel the beep touch either the — or + control.

To cancel the timer (at any point) touch the — and + controls together, the timer is cancelled, and "--" will show in the minute display.

Setting the Timer to Turn One Cooking Zone Off

Touch the heating zone selection control (for example back .

Touch the timer control , the timer indicator will show "10".

Adjust the time setting by touching the — and + controls.

Touch the — or + control of the timer once to increase or decrease by 1 minute.

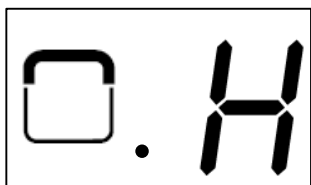

Touch and hold the — or + control of the timer to decrease or increase in 10 minute increments.

If the setting time exceeds 99 minutes, the timer will automatically return to 0 minutes.



Note: The red dot next to power level indicator will illuminate, indicating that zone is selected.

When the timer is set, it will begin to count down immediately. The display will show the remaining time.

To cancel the timer (at any point) touch the  and  controls together, the timer is cancelled, and "--" will show in the minute display.

When the cooking time is reached, the corresponding cooking zone will switch off automatically and the beeper will sound an individual beep.

Setting the Timer to Turn More Than One Cooking Zone Off

If the timer is set to turn off more than one heating zone, the timer indicator will show the lowest time (e.g. if zone "1" is set to 10 minutes and zone "2" is set to 5 minutes, the timer indicator shows 5 minutes).

Note: The red dot next to the power level indicator with the shortest running time will flash.

When the cooking time is reached, the corresponding cooking zone will switch off automatically and the beeper will sound an individual beep.

Efficient Use of Your Hob

Before using your hob for the first time, switch the zones on for a FEW SECONDS to burn off any grease left over from the manufacturing process.

The ceramic glass retains heat, so to make best use of the residual heat, switch off the zone five minutes prior to the end of cooking.

To reduce the cooking time, the zone can be set to the maximum setting at the beginning of cooking, and then reduced during cooking time.

The hob is equipped with zones of different sizes, designed to accommodate most shapes and sizes of pan. For best results, only use pans with flat bottoms and choose an appropriate zone depending on the size of the pan. The most efficient use of the hob is shown below, where the pan and zone are correctly chosen.

Use pan lids where possible to minimise the energy usage of your appliance.

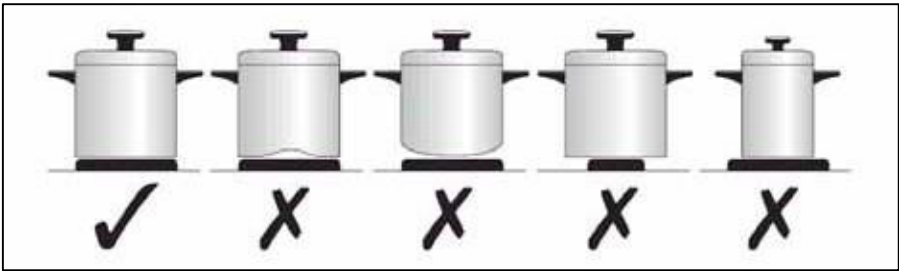

Zone Size	Minimum Pan Size (mm)	Maximum Pan Size (mm)
165mm	145	185
200mm	180	220

It is very important that the pans used on the hob are made of a

suitable material and have the correct type of base. The base should be flat and smooth, as any rough part on the pan base could scratch the ceramic hob top.

Choose pans which are between the sizes recommended in the table above, and with bases that are as non-reflective as possible, e.g. dull and dark.

Only pans recommended for use on ceramic hobs should be used.

Care and Maintenance

Always disconnect the appliance from the power supply before undertaking any cleaning or maintenance.

You should use a non-abrasive cleaner to clean the hob top. Any abrasive cleaner (including Cif) will scratch the surface and could erase the control panel markings.

Types of residues	Clean with	Cleaning advice
Light	Cleaning sponge and soft cloth	Wipe over the zone to be cleaned with a sponge and hot water, and then wipe off with a soft dry cloth.
Accumulated baked-on stains/ dirt, sugar spills or melted plastics	Cleaning sponge or glass scraper and soft cloth	Wipe over the zone to be cleaned with a sponge and hot water, using a ceramic scraper to remove any large marks or stains and then wipe off with a soft dry cloth.
Rings and hard water residues	White vinegar and soft cloth	Pour a small amount of warm white vinegar onto the stain, leave it to stand, and then wipe off with a soft dry cloth.

Troubleshooting

Below is a list of some of the possible malfunctions.

If the problem cannot be resolved as described, contact Customer Services

Problem	Possible Causes	Remedy
The hob cannot be turned on.	No power.	Ensure the hob is connected to the power supply and that it is switched on. Check the fuse in the 13Amp plug. Check whether there is a power outage in your area.
The touch controls are unresponsive.	The controls are locked.	Unlock the controls, see section "Using Your Hob".
The touch controls are difficult to operate.	You may be using the tip of your finger. The control area may be wet.	Use the ball of your finger on the controls. Make sure the control area is dry.
The glass is being scratched.	Rough edged cookware. Unsuitable cleaning products being used.	Use cookware with flat and smooth bases. See "Care and Maintenance".
Some pans make crackling noises.	May be caused by the construction of your cookware.	This is normal for cookware and does not indicate a fault.

Important:

Steam cleaners must not be used when cleaning this appliance.

Electricity Supply to the Hob

Mains electrical voltage: **220 – 240Vac, 50 Hz**

Total rated electrical consumption: **3.0 kW**

Warning: This appliance must be earthed.

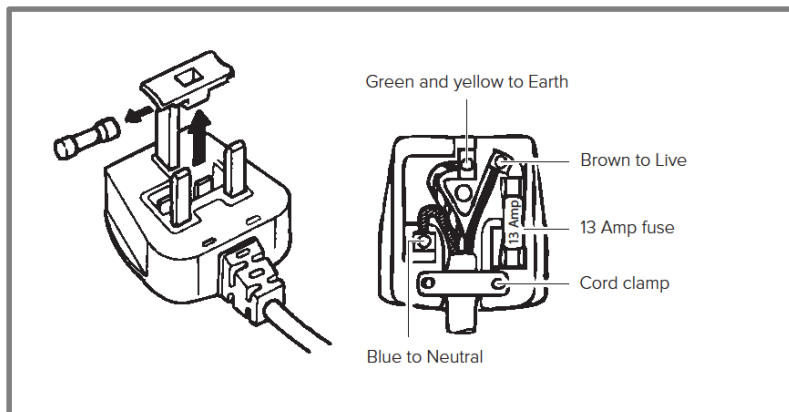

The mains lead of this appliance has been fitted with a BS 1363A 13Amp fused plug. To change a fuse in this type of plug, follow the steps below:

1. Remove the fuse cover and fuse.
2. Fit replacement 13A fuse, ASTA approved to BS 1362 type, into the fuse cover.
3. Replace fuse cover.

Important: Do not use the appliance without the fuse cover in position.

How to connect an alternative plug

If the fitted plug is not suitable for your socket outlet, then it should be cut off and disposed of safely to avoid possible shock hazard. A suitable alternative plug of at least 13 Amp rating to BS 1363 should be used.

As the colours of the wires in the mains lead of this appliance may not correspond with the coloured markings identifying the terminals in your plug, proceed as follows:-

- The wire which is coloured GREEN and YELLOW must be connected to the terminal which is marked with letter (E) or by the Earth symbol or coloured GREEN and YELLOW.
- The wire which is coloured BLUE must be connected to the terminal which is marked with the letter (N) or coloured BLACK.
- The wire which is coloured BROWN must be connected to the terminal which is marked with the letter (L) or coloured RED.

If in doubt regarding the electrical connection of this appliance, consult a qualified electrician. Do not shorten the supply cable, the appliance may require removing for servicing.

N.B. Ensure that the plug socket is situated in an easily accessible place after installation.

Fitting the Hob

Unpacking the Hob:

Take care not to lose or mishandle any parts.

Fitting Position of the Hob:

This appliance must be installed a minimum of 50mm from any back wall and a minimum of 190mm away from any adjacent vertical surfaces, e.g. a tall cupboard end panel. This may be reduced to 100mm if the adjacent surface is resistant to fire (tiles or steel, for example). These dimensions are shown in Fig.4.

If Fitting a Cooker Hood Above the Hob:

If a cooker hood is to be installed above the hob, the height of the hood above the hob must be at least 600mm (650mm is recommended) (Fig.5). If the instructions supplied with the hood dictate that the hood must be installed at a height greater than 600mm, then that height is the minimum required.

Wall Furniture Requirements:

The minimum height of any cabinet immediately above the hob is 900mm. The minimum height of any adjacent units (including light pelmets) is 400mm, unless they are manufactured from a material resistant to fire (steel, for example)

Notes:

- Do not position this appliance above a refrigeration unit. The heat generated may cause the refrigeration unit to fail.

- This appliance is designed to be installed into cabinet units capable of withstanding temperatures of 65°C or greater above ambient temperature.
- If there is no oven to be built in below the hob, an isolation shelf should be fitted to protect the user from high temperatures.
- If the hob is to be installed above a working drawer, then a partition should be fitted to protect the contents and user from the heat generated during use. This should be fitted 100mm below the hob.
- Never place perishable foods in the cupboard below the appliance.

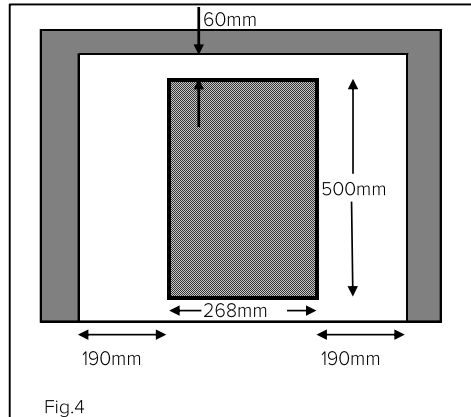

How to Install the Hob

Overall dimensions of the hob: Width: 288mm Depth: 520mm
Worktop cut-out dimensions: Width: 268mm Depth: 500mm

1. Make the required hole in the worktop. Before doing this, you must check the instructions supplied with any cooker hood to ensure that you will have the required clearance. The cut-out (Fig.4) shows a 60mm gap from the wall to the cut-out edge. The distance from the hob,

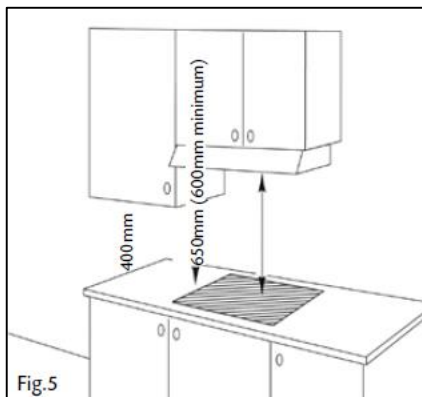

when fitted, to the back wall is 50mm. If a splashback/worktop upstand is to be fitted, take this into account when cutting the hole. The minimum distance that the hob should be positioned away from the rear wall or splashback is 50mm.

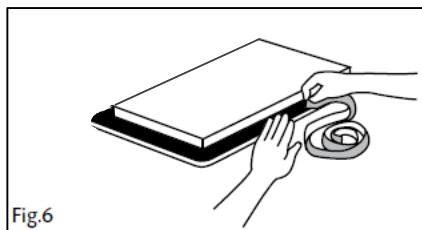

2. Position the hob seal, as shown in Fig.6, ensuring that the ends meet without overlapping. Do not use silicone type sealant.

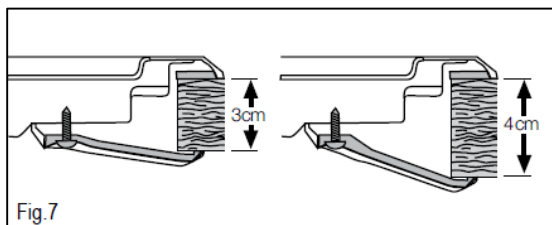

3. Secure the hob to the worktop using brackets and screws supplied, as shown in Fig.7. Remove any excess sealant after tightening the brackets. Do not over-tighten the fixing

NOTES:-

Energy Efficiency Information			
Attribute	Symbol	Value	Units
CDA model		hc3620	
Type of hob		Ceramic hob	
Number of cooking zones and/or areas		2	
Heating technology (induction cooking zones and cooking areas, radiant cooking zones, solid plates)		Radiant cooking zones	
For circular cooking zones or area: diameter of useful surface area per electric heated cooking zone, rounded to the nearest 5mm	∅	Zone1: 16.5, Zone2: 20.0	cm
For non-circular cooking zones or areas: length and width of useful surface area per electric heated cooking zone or area, rounded to the nearest 5mm	L W	NA	cm
Energy consumption per cooking zone or area calculated per kg	EC _{Electric cooking}	Zone1: 192.9, Zone2: 180.7	Wh/kg
Energy consumption for the hob calculated per kg	EC _{Electric hob}	186.8	Wh/kg

E & O E. All instructions, dimensions and illustrations are provided for guidance only. CDA reserve the right to change specifications without prior notice.



Please contact our Customer Care Department for Service on the details below

Customer Care Department • The CDA Group Ltd. • Harby Road • Langar • Nottinghamshire • NG13 9HY
T : 01949 862 012 F : 01949 862 003 E : service@cda.eu W : www.cda.eu