

|C|D|A|

VK903

Compact combination microwave oven
Use and maintenance

Contents

3	Important information
6	Before first use
7	Control panel
8	Using the touch controls
8	Switching the appliance on and off
9	Setting the clock
9	Setting the minute minder
10	Functions
10	Selecting microwave functions
11	Selecting oven functions
11	Pausing and altering functions
11	Stopping functions
12	Auxiliary functions and settings
12	Safety key lock
13	Interior lighting
13	Operating time limiter
14	Semi-automatic cooking
15	Automatic cooking
16	Care and maintenance
18	Cleaning
20	Installation
22	Mains electrical connection

Important information

This appliance must only be used for the purpose for which it is intended, i.e. domestic cooking. Any other use could be dangerous and may lead to premature failure of the appliance.

The CDA Group Ltd. cannot be held responsible for injuries or losses caused by incorrect use or installation of this product. Please note that CDA reserve the right to invalidate the guarantee supplied with this product following incorrect installation or misuse of the appliance.

Under no circumstances should any external covers be removed for servicing or maintenance except by suitably qualified personnel.

User information:

- Ovens become hot during and immediately after use.
- The oven door can become very hot during operation.
- After use, please ensure that the oven is switched 'Off'.
- Keep children away from the appliance when in use, and immediately after use.
- Keep the oven door closed whilst grilling.

Appliance information:

Please enter the details on the appliance rating plate below for reference, to assist CDA Customer Care in the event of a fault with your appliance and to register your appliance for guarantee purposes.

Appliance Model	
-----------------	--

Serial Number	
---------------	--

Important information

EU Declarations of Conformity:

This oven has been designed, constructed and marketed in compliance with safety requirements of EU Directive 2014/35/EU (LVD) and requirements of EU Directive 2014/30/EU (EMC).

Parts intended to come into contact with food conform to 1935/2004/EC.

IMPORTANT INFORMATION FOR CORRECT DISPOSAL OF THE PRODUCT IN ACCORDANCE WITH EU DIRECTIVE 2012/19/EU.

At the end of its working life, the product must not be disposed of as urban waste. It must be taken to a special local authority differentiated waste collection centre or to a dealer providing this service.

Disposing of a household appliance separately avoids possible negative consequences for the environment and health deriving from inappropriate disposal and enables the constituent materials to be recovered to obtain significant savings in energy and resources. As a reminder of the need to dispose of household appliances separately, the product is marked with a crossed-out wheeled dustbin. 

Important information

- Read the user instructions carefully before using the oven for the first time.
- Follow the instructions for first use of the oven.
- Clean the oven regularly.
- Remove spills as soon as they occur.
- Always use oven gloves when removing shelves and trays from the oven.
- Do not allow children near the oven when in use.
- Do not allow fat or oils to build up on the oven shelves, grill pan or oven base.
- Do not place any cooking utensils or plates directly on the oven base.
- Always grill with the oven door closed.
- Do not grill food containing fat without using the grill pan grid.
- Do not cover the pans, grids or the oven walls with aluminium foil.
- Do not use the oven tray for roasting.
- Do not perform maintenance or cleaning of the oven without first switching off the electricity supply. If the oven has recently been used, allow to cool.
- Do not place hot enamel parts in water. Leave them to cool first.
- Do not allow vinegar, coffee, milk, saltwater, lemon or tomato juice to remain in contact with enamel parts.
- Do not use abrasive cleaners or powders that will scratch the surface of the enamel or stainless steel.
- Do not attempt to repair the internal workings of your oven.
- Do not cover the oven floor with aluminium foil.

Before first use

First use

Before using the oven for the first time we recommend that, with the power supply off, you clean the oven with soapy water. Once done, rinse carefully, remove all accessories from the appliance and then heat on the below programme at maximum temperature for the specified time. A slightly unpleasant smell may be produced, caused by grease remaining on the oven element from the production process.



30 minutes full grill with rear element and fan

Please note:

This oven has been fitted with a cooling fan to achieve maximum efficiency and to maintain low surface temperatures. The cooling fan will switch on automatically when the oven switches on. It is normal for the cooling fan to run for an hour or more after use, depending on the duration, temperature and type of cooking programme used.

- The oven light remains on for every cooking function for 1 minute then will go out. The oven light can be switched on or off at any time.
- Switching the oven off will result in any semi-automatic or automatic cooking to be cancelled
- We recommend preheating the grill for 5 minutes before each use.

Control panel

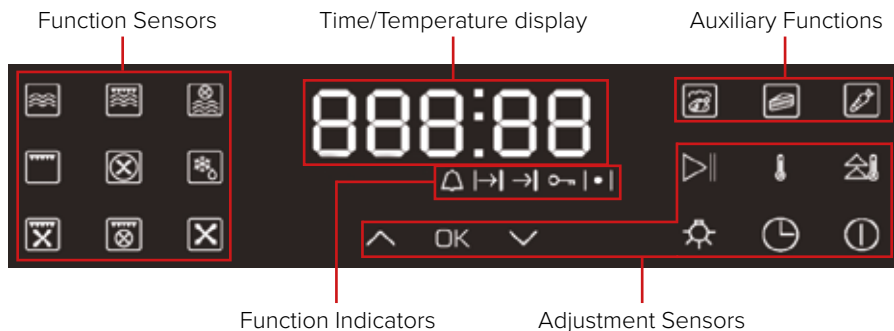

On/Off sensor



Plus sensor



Time sensor



Minus sensor



Interior light sensor



Confirm sensor



Start/Pause sensor



Minute minder indicator



Temperature sensor



Duration indicator



Rapid preheating sensor



End of cooking indicator



Safety key lock indicator



Function active indicator

Using the touch controls

The touch controls should be used with the flat of your finger, rather than the fingertip.

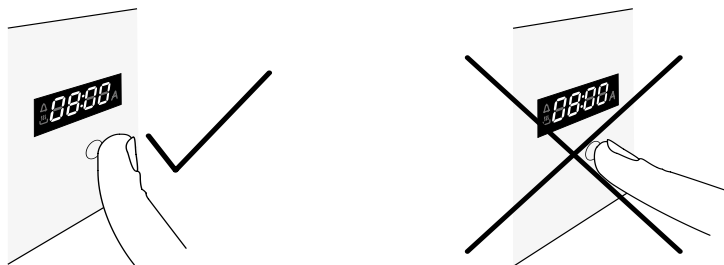

Switching the appliance on and off

To switch the appliance on

Touch and hold the 'On/Off' sensor ① for approximately 3 seconds and until the appliance beeps.

To switch the appliance off

Touch and hold the "On/Off" sensor ① for approximately 3 seconds and until the oven beeps. All displays except for the time display should extinguish.



Please note: To switch the appliance off completely, i.e. before cleaning it, you will need to switch it off at the mains isolation switch.

Setting the clock

- In standby mode, press and hold the timer sensor  until the minutes of the display flash.
- Use \wedge and \vee to set the minutes. Touch the OK sensor to confirm the setting.
- The hours of the display will now be flashing. Use \wedge and \vee to set the hours. Touch the OK sensor to confirm the setting.

Note: The clock can only be set in 24 hour format

Setting the minute minder

Select a function and touch the  sensor until the minute minder indicator  flashes. Then, use the \wedge and \vee sensors to set the desired time. Touch the OK sensor to confirm the setting or wait 5 seconds and the setting will save automatically and the  indicator will be illuminated on the display.









The minute minder can be set between 1 minute and 24 hours.

Once the duration time has elapsed you will hear beeping and the display will flash 0:00. Touch the  sensor to mute the beeping and return to standby mode. If no sensor is pressed, the beeping will stop after 60 seconds but the display will continue to flash.









Please note: The minute minder function is available for cooking and defrosting functions, not microwave functions.

Functions







Below is a table of functions for the appliance including any adjustable settings

Icon	Function	Power	Preset temperature (°C)	Microwave power (W)	Preset Time (min)	Adjustable temperature range	Adjustable Microwave power range	Minute minder
	Microwave	1740 W	/	800	1	/	100 - 900W	NO
	Microwave and grill	1740 W/ 1900 W	180	400	10	110 - 180°C	200 - 600W	NO
	Microwave + rear element + fan	1740 W/ 3100 W	180	400	10	110 - 200°C	200 - 600W	NO
	Defrost	1740 W	/	400	10	/	/	NO
	Top grill	1900 W	180	/	Default	50 - 230°C	/	YES
	Rear element + fan	3100 W	180	/	Default	50 - 230°C	/	YES
	Top grill + fan	1900 W	180	/	Default	50 - 230°C	/	YES
	Top grill + rear element + fan	3100 W	180	/	Default	50 - 230°C	/	YES
	Fan defrost	20W	/	/	Default	/	/	YES

Selecting a function and beginning cooking (microwave functions)

- Touch a sensor on the control panel to enter that functions settings. The display will show the functions default time setting
- Pressing the  sensor will allow you to change the operating time for the function. Use the  and  to adjust the time. Touch the OK sensor to confirm the setting
- Pressing the  sensor will allow you to change the power level of the microwave and temperature if applicable. Use the  and  to adjust the power. Touch OK to confirm the setting
- Once you are happy with the settings, press the  sensor to begin cooking. The display will show the duration left on the cooking function and the Duration indicator  and the Function active indicator  will both be illuminated

Selecting a function and beginning cooking (oven functions)

- Touch a sensor on the control panel to enter that functions settings. The display will show the default temperature setting if a cooking function is selected. If a defrost function is selected the display will show the default time.
- Pressing the  sensor will allow you to set the minute minder. Use the  and  to adjust the time and touch the OK sensor to confirm the setting
- Pressing the  sensor will allow you to change the temperature of the setting. Use the  and  to adjust the temperature and touch the OK sensor to confirm the setting
- Once you are happy with the settings, press the  sensor to begin the function. For a cooking function, the display will show the current temperature and the Function active indicator | • | will be illuminated. For a defrost function, the display will show the current time or the time left on the function, if applicable.

Pausing and altering functions

Simply press the Start/Pause sensor  whilst the appliance is in use. This will allow you to suspend operation temporarily. To resume the function, simply press the sensor once more. Whilst the appliance is paused you can adjust the temperature, where available, without affecting the running time of the function.



Note: Opening the appliance door will also temporarily pause the function. Closing the door will resume the function automatically.

Stopping a function

Simply press and hold the on/off sensor  for approximately 1 seconds.

Auxiliary functions

This appliance features a number of preset functions which create the ideal cooking environment (time, temperature etc.) for certain dishes. Below is a table of these functions and their adjustable settings.

Icon	Food type	Function	Power	Preset temperature (°C)	Microwave power (W)	Preset time (min)	Adjustable temperature range (°C)	Adjustable microwave power range	Minute minder
	Meat	Fan, Grill & Microwave	900W	200	900W	20	180 - 220	400W - 900W	NO
	Cake	Fan, Rear Element & Microwave	900W	160	900W	25	150 - 180	600W - 900W	NO
	Vegetables	Microwave	800W	/	800W	3	/	800W - 900W	NO

Auxiliary function settings

It is possible to alter the settings of the auxiliary functions to suit your preferences. To do this simply select the function you require and press ▷||. Press ▷|| again and the function will pause, whilst paused you can alter any applicable settings such as temperature, duration or microwave power by pressing the appropriate sensor and using the ^ and v sensors. When you are ready to resume the function simply press ▷||.

Safety key lock

This appliance is equipped with a safety key lock to prevent accidental use. The safety key lock can be activated when the appliance is in standby mode (i.e. just the clock displayed) or whilst a function is running. To activate the safety key lock, simultaneously press and hold both the v and ⌚ sensors until the 🔒 indicator illuminates. To deactivate the safety lock simply press and hold both sensors again and the indicator will go out.

Interior lighting

The interior lighting will come on automatically when the oven is in use and will turn itself off automatically after 1 minute but can be turned on and off as you wish. The light will also turn on after opening the oven door. The light can be turned on when the oven is in standby without a function in operation. Simply press the light sensor  to operate the light as necessary.

If the bulb in your appliance should fail, please contact CDA Customer Care to arrange a service visit. The bulb and appliance must not be serviced by anyone except a CDA authorised service agent.

Operating time limiter

Each temperature, when used outside of semi and automatic cooking, has an operating time limiter to help to prevent damage to the internal components of this appliance. After a certain working time at given temperatures the appliance will switch the function off automatically. The temperatures and associated maximum operating times are listed in the table below.

Temperature	Maximum operating hours
20 - 120°C	24
121 - 200°C	6
201 - 230°C	4

Please note: The cooking time can be set between 0 and 10 hours. The end of cooking time can be set to 10 hours ahead of the current time. If an end of cooking time is set, then this will take priority, for example over the current time, on the time display.

Semi automatic cooking

This function allows for a cooking time to be set. When the set time elapses the oven will switch the set function off and an acoustic signal will sound to alert the user. The cooking time available ranges from between 1 minute and 10 hours.

To switch on semi automatic cooking

- First select a heating function and the temperature required
- Press the ⌚ sensor twice and the |→| indicator will flash on the display
- Use the ^ and v sensors to adjust the duration as needed and touch OK to confirm the setting or alternatively wait 5 seconds and the duration will automatically set
- To clear the duration setting, either cycle down the minutes using the ^ and v sensors until the display shows 0:00 or touch the ⌚ sensor and you will return to standby mode and you can begin the function again

During the cooking process the |→| indicator will be illuminated.











Once the duration time has elapsed you will hear beeping and the display will flash 0:00. Touch the ⌚ sensor to mute the beeping and return to standby mode. If no sensor is pressed, the beeping will stop after 60 seconds but the display will continue to flash.

Automatic cooking

This function allows for a delay to be set for cooking and an automatic end time. For example, if you set the cooking duration to 1 hour, and the end time to 15:00, then the oven will activate the function at 14:00.

Note: Automatic cooking is not available on any functions using the microwave

To switch on automatic cooking

- First select a heating function and the temperature required
- Press the  sensor twice and the  indicator will flash on the display
- Use the  and  sensors to adjust the duration as needed.
- Press the  sensor again and the  indicator will flash on the display and the end time will also be shown
- Use the  and  sensors to adjust the end time and touch OK to confirm the setting
- To clear the duration setting, either cycle down the minutes using the  and  sensors until the display shows 0:00 or touch the  sensor and you will return to standby mode and you can begin the function again.

During the cooking process the  indicator will be illuminated.

Once the duration time has elapsed you will hear beeping and the display will flash 0:00. Touch the  sensor to mute the beeping and return to standby mode. If no sensor is pressed, the beeping will stop after 60 seconds but the display will continue to flash.

Care and maintenance

It is important, before carrying out any cleaning or maintenance, that you disconnect or switch off the appliance at the power supply. If the oven has been in use, let the cavity and any elements cool down sufficiently before attempting any cleaning or maintenance.

Removing the appliance door

In order to allow for easier access into the oven cavity for cleaning, it is possible to remove the door. Before removing the door, ensure that you have an area prepared in which you can place the removed door. This area should ideally be protected by something like a folded, dirt-free, towel to help prevent damage to surfaces and the door.

- Open the door fully
- Lift and tilt the safety catch part of the hinge (Fig .1) so that it is fully extended and points towards the door.
- Close the door most of the way, lift it slightly and then pull it, safely but firmly, towards you.

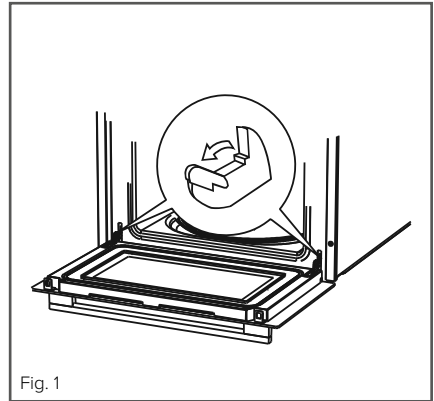

Replacing the appliance door

- Hold the door to the appliance in the closed position and manoeuvre the hinges so that the part of the hinge, highlighted by the star in fig. 2, inserts into the hinge slot in the cavity frame.
- Next, ensure the notch on the underside of the hinge sits on the lip of the hinge slot. Open the door fully. Each hinge should be seated in the same way as the hinge in fig. 3. If it is not, follow the steps for removing the door and try replacing it again.
- Finally, lift the safety catch part of the hinges back into place so that they are lying flat against the hinges.

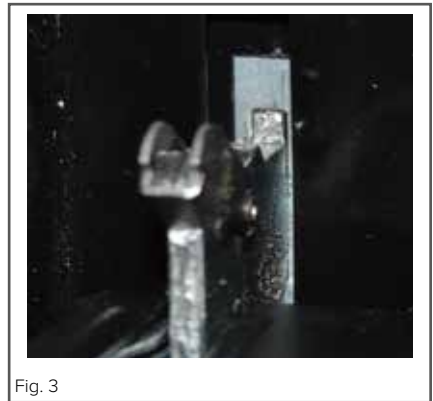
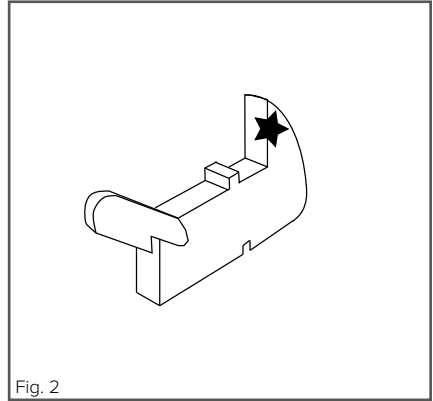

Please note: If the hinge safety catches are not in the correct place then the door and/or appliance may receive damage when attempting to close the door.

Cleaning

IMPORTANT

- **Before any maintenance is started involving electrical parts, the appliance must be disconnected from the power supply.**
- **If the oven has been in use, let the oven cavity and the heating elements cool down before attempting any maintenance.**
- **Steam cleaners must not be used when cleaning this appliance.**
- **Once care and maintenance is complete, ensure that all parts are correctly replaced before using the oven.**
- **Do not store flammable material in the oven.**
- **Do not allow grease or food particles to build up around the door.**

The oven exterior

As the oven has a stainless steel or enamel surface, you should use a nonabrasive cleaner. Any abrasive cleaner (including Cif) will scratch the surface and could erase the control panel markings.

Inside of oven

It is recommended that the interior of the oven be cleaned after every use using suitable products, especially if any spillage has occurred. The shelves can be removed and washed by hand or in the dishwasher.

Stainless steel

Stainless steel can be effectively cleaned by simply using a dilute solution of water and mild detergent and drying to a shine with a clean cloth. Proprietary stainless steel cleaners are available. We recommend a clean microfibre cloth for cleaning stainless steel surfaces.

Grill

When used regularly, the grill element does not need cleaning as the intense heat will burn off any splashes. The interior ceiling may need regular cleaning, which should be done with warm water, detergent and a sponge. If the grill is not used regularly, it should be run for 10 minutes every month to burn off any splashes, in order to reduce the risk of fire.

IMPORTANT:

When correctly installed, your product meets all safety requirements laid out for this type of product. However, special care should be taken around the rear or the underneath of the appliance as these areas are not designed or intended to be touched and may contain sharp or rough edges that could cause injury.

Installation

The appliance can be installed under a worktop or in a wall unit (open or closed) with the appropriate dimensions for recessed installation.

Centre the oven in the unit, ensuring that there is as much of a gap as possible, for ventilation purposes, between the appliance and the surrounding unit. The material of the unit supporting the appliance must be heat resistant (or covered with a heat resistant material). For greater stability, attach the oven to the unit with four screws through the holes provided on the side panels.

If the appliance is to be installed under a worktop, ensure the top rail has been removed to provide free airflow around the product.

Do not use your appliance immediately after moving it from a cold location, as condensation may cause a malfunction. Wait approximately 1-2 hours before use.

Installation diagrams are on page 21.

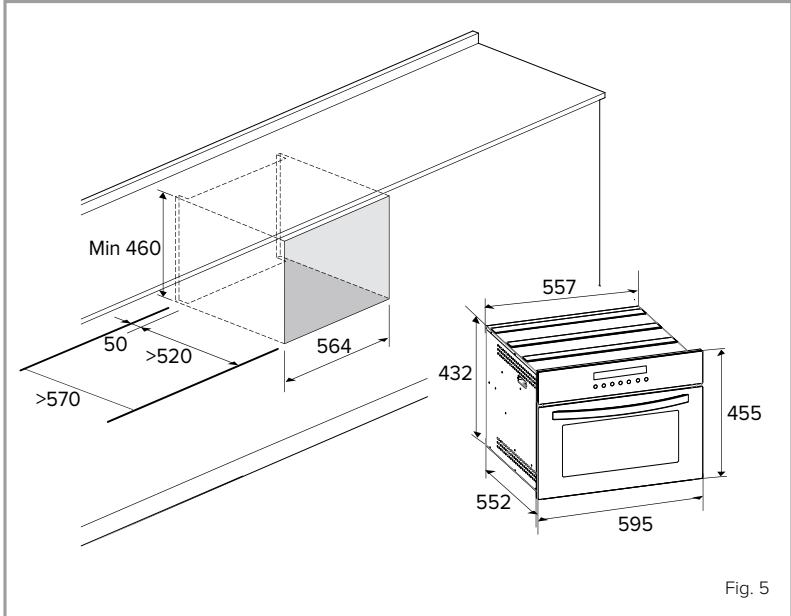
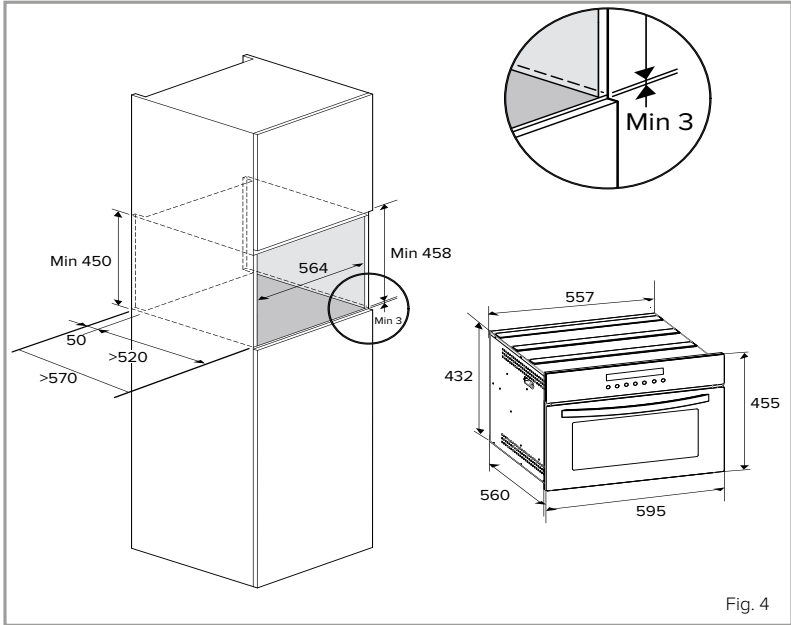

Mains electrical connection

Warning! This appliance must be earthed

This appliance is supplied with a 3 core mains cable; the wires are in accordance with the following code:

Green and Yellow = Earth

Blue = Neutral

Brown = Live

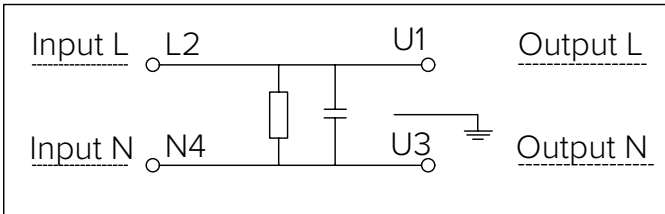

We recommend that the appliance is connected by a qualified electrician, who is a member of the N.I.C.E.I.C. and who will comply with the I.E.T. and local regulations.

This appliance is intended to be connected to fixed wiring and is not suitable for connection to a 13A plug.

This appliance is intended to be connected to fixed wiring by a double pole switch, having a contact separation of at least 3mm in all poles. The switch must be positioned no further than 2m from the appliance.

Please note:

- The mains cable must only be replaced by a qualified electrician or service engineer and must be of equivalent or better rating (i.e. 1.5mm², HO5RR-F).
- The current rating of the fuse or circuit breaker protecting this appliance should be marked on the outlet (13A).
- Assembly and electrical connection should be carried out by specialised personnel.

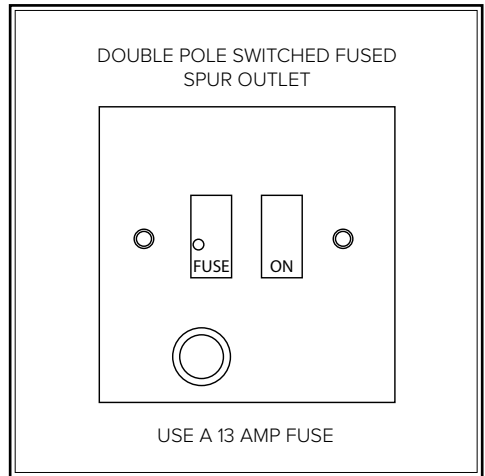

- When installing this product we recommend you seek the help of another individual.
- The mains isolation switch must be accessible after installation.

Mains electrical voltage:

240Vac, 50Hz

Total rated electrical consumption:

3.1 kW

Microwave output:

900W, 2450MHz

The CDA Group

Harby Road

Langar

Nottinghamshire

NG13 9HY

Sales Department

Phone: 01949 862010

Email: sales@cda.eu

CDA Customer Care

Phone: 01949 862012

Email: customer.care@cda.eu

