



# SK900

## Single Oven

Installation, use and maintenance



## Contents:

4	Important information
6	Important safety notes
7	First use of the oven
8	Oven controls
9	Functions
10	Rapid preheating
11	Pyrolytic cleaning function
12	Preset programmes
13	Additional settings
13	Changing the language
14	Adjustable lighting settings
15	Service and factory reset
16	Electronic programmer/timer
16	Minute minder
17	Semi-automatic cooking
18	Automatic cooking
20	Using the temperature probe
22	Safety key lock
22	Eco mode
23	Interior lighting
23	Active pause
24	Cleaning and maintenance
24	Cleaning the oven exterior
24	Cleaning the oven interior
25	Removing the appliance door
26	Replacing the appliance door
26/27	Removing the inner door glass

## Contents:

28	Glass guides
29 - 30	Removing shelf supports, runners and liners
32 - 34	Changing the oven light bulb
34	Adjusting the oven door
34	Mains electrical connection
36	Troubleshooting
37	Energy Efficiency Information

**IMPORTANT: Please read the user instructions carefully before using the appliance for the first time and before installing it. Failure to install the oven as per the user manual could invalidate the warranty.**

# Important

This appliance must only be used for the purpose for which it is intended, i.e. domestic cooking. Any other use could be dangerous and may lead to premature failure of the appliance.

The CDA Group Ltd cannot be held responsible for injuries or losses caused by incorrect use or installation of this product. Please note that CDA reserve the right to invalidate the guarantee supplied with this product following incorrect installation or misuse of the appliance.

Under no circumstances should any external covers be removed for servicing or maintenance except by suitably qualified personnel.

## **User information:**

- Ovens become hot during and immediately after use.
- The oven door can become very hot during operation.
- After use, please ensure that the oven is off.
- Keep children away from the appliance when in use, and immediately after use.
- Do not allow children to play with or on the appliance.
- Keep the oven door closed whilst grilling.

## **Appliance information:**

Please enter the details from the appliance rating plate on to the following page for reference, to assist CDA Customer Care in the event of a fault with your appliance and to register your appliance for guarantee purposes.

Appliance Model	
-----------------	--

Serial Number	
---------------	--

### **EU Declarations of Conformity:**

This oven has been designed, constructed and marketed in compliance with safety requirements of EU Directive 2014/35/EU (Low voltage) and requirements of EU Directive 2014/30/EU.

This appliance has been manufactured to the strictest standards and complies with all applicable legislation, including Electrical safety (LVD) and Electromagnetic interference compatibility (EMC). Parts intended to come into contact with food conform to 1935/2004/EC.

### **IMPORTANT INFORMATION FOR CORRECT DISPOSAL OF THE PRODUCT IN ACCORDANCE WITH EC DIRECTIVE 2012/19/EU.**

At the end of its working life, the product must not be disposed of as urban waste. It must be taken to a special local authority differentiated waste collection centre or to a dealer providing this service.

Disposing of a household appliance separately avoids possible negative consequences for the environment and health deriving from inappropriate disposal and enables the constituent materials to be recovered to obtain significant savings in energy and resources. As a reminder of the need to dispose of household appliances separately, the product is marked with a crossed-out wheeled dustbin. 

---

## Important

- Read the user instructions carefully before using the oven for the first time.
- Follow the instructions for first use of the oven.
- Clean the oven regularly.
- Remove spills as soon as they occur.
- Always use oven gloves when removing shelves and trays from the ovens.
- Do not allow children near the oven when in use.
- Do not allow fat or oils to build up on the oven shelves, grill pan or oven base.
- Do not place any cooking utensils or plates directly on the oven base.
- Always grill with the oven door closed.
- Do not grill food containing fat without using the grill pan grid.
- Do not cover the trays or the oven walls with aluminium foil.
- Do not perform maintenance or cleaning of the oven without first switching off the electricity supply. If the oven has recently been used, allow to cool.
- Do not place hot enamel parts in water. Leave them to cool first.
- Do not allow vinegar, coffee, milk, saltwater, lemon or tomato juice to remain in contact with enamel parts.
- Do not use abrasive cleaners or powders that will scratch the surface of the enamel.
- Do not attempt to repair the internal workings of your oven.

## First use of the oven

The metal casing of this appliance has been coated with a preservative to protect it during transport and storage. This should be removed during installation by using a non-abrasive stainless steel cleaner. Always follow the instructions given with the cleaner being used. Remove all protective film from the oven accessories.

Before using the oven for the first time we recommend that you remove all packaging materials and then clean the oven with soapy water and rinse carefully. **Set the current time on the programmer as per page 16.** Heat on each of the below programmes at maximum temperature for the specified time. A slightly unpleasant smell may be produced, caused by grease remaining on the oven elements from the production process.



15 minutes full grill



30 minutes fan oven

### Please note:

- This oven has been fitted with a cooling fan to achieve maximum efficiency and to maintain low surface temperatures. The cooling fan will switch on automatically when the oven switches on. It is normal for the cooling fan to run for an hour or more after use.
- This oven offers 18 different language options. These are; English, German, Polish, Russian, Czech, Serbian, Lithuanian, Estonian, Latvian, French, Spanish, Turkish, Swedish, Norwegian, Finnish, Danish, Italian and Dutch. When switching the appliance on for the first time, 'Select language' is displayed. Use the  $\wedge$  and  $\vee$  sensors to choose the desired language and then press OK.
- **Use the back sensor  $\leftarrow$  for any incorrect entry at any point.**

# Oven controls



**A** - Function sensor

**B** - Programme sensor

**C** - Rapid preheating sensor

**D** - Oven light sensor

**E** - Temperature sensor

**F** - Clock sensor

**G** - Timer sensor

**H** - Plus setting sensor

**J** - Minus setting sensor

**K** - Back sensor

**L** - Confirm sensor

**M** - Time display

## IMPORTANT:

- **You must set the current time on the oven programmer, as per page 16, for the oven to operate properly.**
- **Use the power sensor (I) to switch the oven on & off (standby).**













**Please note:** The display backlight brightness changes according to the time of day. During the hours of 05:00 - 22:00 the brightness is set to high. During the hours of 22:00 - 05:00 the brightness is set to low. The state of use of the oven also determines the brightness; when it is off/on standby the backlight brightness is low. When it is in use the backlight brightness is high.

The display next to the | • | symbol can show the target temperature, temperature adjustment and also the current temperature.



# Functions



Each of the oven functions uses different elements within the oven to offer you the best choice of cooking every time. These are explained on the quick reference table below. The levels referenced in the 'Default setting' column are the recommended shelf positions (numbers are on the oven cavity sides, behind the door, to aid you).

Display indication	Oven functions and (Name)	Default setting
	FAN + CIRCULAR ELEMENT (FAN OVEN)	170°C Level 3
	FAN OVEN WITH ECO* (FAN OVEN ECO)	170°C Level 3
	FAN + BOTTOM ELEMENT (FAN OVEN + LOWER HEAT)	220°C Level 2
	BOTTOM ELEMENT (WARMING OVEN)	200°C
	BOTTOM ELEMENT + TOP ELEMENT (CONVENTIONAL)	180°C Level 3
	BOTTOM ELEMENT + TOP ELEMENT + FAN (FAN ASSISTED OVEN)	170°C Level 3
	GRILL + FAN TOP ELEMENT (FANNED FULL GRILL)	280°C Level 4
	(DEFROST)	--°C
	GRILL + TOP ELEMENT (FULL GRILL)	200°C Level 2
	TOP ELEMENT (BROWNING)	180°C
	HALF GRILL	280°C Level 4
	PYROLYTIC CLEANING (PYROLYTIC FUNCTION)	480°C



The minimum adjustable temperature for all functions is 30°C. The maximum for all functions is 280°C, except for browning and roasting, which offer 240°C as a maximum.

\*ECO Fan heater is an optimised heating function designed to save energy when preparing food.

## Setting a function and adjusting a temperature

- If not already so, switch the oven on using the power sensor . Press the function sensor  and use the  $\wedge$  and  $\vee$  sensors to select the desired function as per the table opposite (these are not in order). Press OK.
- Use the  $\wedge$  and  $\vee$  sensors to set the required temperature and then press the OK sensor.
- The temperature can be adjusted at any time during a function except for when the safety key lock is active. To do this, press the temperature sensor  once to see the current oven temperature and then once more to activate temperature adjustment. Temperature adjustment is active when the temperature is flashing.

## Activating rapid preheating

Most functions allow for the rapid preheating feature to be used (it is also an automatic feature with some preset programmes). To activate this feature, simply select a function and temperature as per the above and then press the rapid preheating sensor . The corresponding symbol should illuminate on the display panel. The oven will now reach the set temperature significantly faster than if the feature were inactive. Once the temperature has been reached, the symbol on the display panel will flash and an alarm will sound. Press the rapid preheating sensor  to cancel both notifications.

## Cancelling rapid preheating

To cancel the rapid preheating feature at any time, simply touch and hold the rapid preheating sensor  for approximately 5 seconds. The corresponding symbol on the display panel should go out.

### **When fan grilling, please note:**

- Always grill with the oven door closed.
- The grill pan does not need to be as close to the grill as possible.
- Do not grill for more than 30 minutes at a time.
- Preheat the grill for up to five minutes with the oven door closed.

### **When grilling, please note:**

- Always grill with the oven door closed.
- Put the grill pan as close to the grill as possible.
- Do not grill for more than 30 minutes at a time.
- Preheat the grill for up to five minutes with the oven door closed.

## **Pyrolytic cleaning function**

- This function heats the oven to approximately 480°C (for a preset time which is adjustable - 90, 120 & 150 mins) which will burn off or loosen any stubborn grease, stains or dirt inside the oven, leaving behind a debris that simply has to be wiped up or swept from the interior afterwards.
- Select the function (see table on page 9) and press OK. You will be prompted to remove **all** items from the oven (see pages 29 and 30 for help). Do so and press OK. Set the duration - set a longer cycle for heavier soiling. Press OK. Once the appliance door is closed the cycle will begin. When complete, an acoustic signal will sound. The door will unlock once a safe temperature is reached. Switch the oven off and then the power off at the mains supply and clean the interior as per the cleaning and maintenance section (page 24).

**Remember that the oven interior will be hot to the touch, exercise extreme care and always wear adequate Personal Protective Equipment (PPE).**

# Preset programmes

This appliance features a number of preset programmes which create the ideal cooking environment (time, temperature etc.) for certain dishes. These are made available by pressing the programme sensor . After doing so, there are a number of categories and sub-categories, as follows:

<b>Pastries</b>
Crumble
Bread
Cookies
Muffins
Sponge cake
Swiss roll
Cheesecake
Fruit cake

<b>Frozen products</b>
Fish
Chips
Lasagne

<b>Pizza</b>
Thin base
Frozen
Thick base

<b>Poultry</b>
Chicken
Turkey
Goose
Duck

<b>Meat</b>
Pork
Lamb
Veal
Beef



<b>Additional programmes</b>
Dough proving
Pasteurization
Heating plates
Keep food warm
Drying

<b>Low temperature baking</b>
Roast pork
Pork neck
Beef roulade
Medium-rare fillet of beef
Rare fillet of beef
Veal
Pork loin
Roast turkey
Rare roast beef

Press OK to select the desired programme. With some preset programmes you will need to enter the item's weight. You will be prompted at this stage if so. Simply use the  $\wedge$  and  $\vee$  sensors to set the correct weight and press OK. There are limits to the quantity each programme can cook at once.

You can alter the temperature of the preset programme. To do this, press the temperature sensor  once to see the current oven temperature and then once more to activate temperature adjustment. Temperature adjustment is active when the temperature next to the  $| \bullet |$  symbol is flashing. Set the temperature using the  $\wedge$  and  $\vee$  sensors and then press OK. The preset programme name will disappear, replaced by the function name, but any durations will remain in place (e.g. meat cooking times).

## Additional settings

This appliance features a number of adjustable settings. The settings menu can be accessed by pressing the temperature sensor  and the timer sensor  together. The appliance must be on (i.e. not on standby) to do this, but must have no function active.

Once the settings menu has been entered, there will be a list of seven options that you can scroll through using the  $\wedge$  and  $\vee$  sensors and enter by pressing OK :

### Language

Using this setting, the display language of the oven can be changed. Use the  $\wedge$  and  $\vee$  sensors to scroll through the available languages

(a list is on page 7). Press OK to select the desired language. A confirmation message will be displayed in the new language, press OK to confirm.

To go back to the default language, press the back sensor  $\leftarrow$ . To continue changing the language, for example if you have pressed okay by accident, continue using the  $\wedge$  and  $\vee$  sensors.

## **Lighting**

Using this setting, the oven lighting (interior) can be set to continuous or eco. Eco is the factory default setting. Press OK to enter the setting and use the  $\wedge$  and  $\vee$  sensors to cycle through the two options and press OK to confirm. When continuous is selected, the light will always be on when the door is open, and during most heating functions. When eco is set (as standard) the interior light will behave as per page 23.

## **Handle brightness**

Using this setting, the oven handle brightness can be adjusted. Press OK to enter the setting and use the  $\wedge$  and  $\vee$  sensors to adjust the brightness, expressed in a percentage. The brightness will adjust as you adjust the level, so that you can see the effect of your adjustment. Press OK to confirm.

## **Display brightness**

Using this setting, the brightness of the display can be adjusted for each mode; active, standby and night mode.. Press OK to enter the setting and use the  $\wedge$  and  $\vee$  sensors to adjust the brightness, expressed in a percentage. The brightness will adjust as you adjust

the level, so that you can see the effect of your adjustment. Press 0K to confirm. The display will still behave as per page 8 during night and daytime hours.

## **ECO**

Using this setting, the oven can be set to normal operation or eco. Eco is explained on page 22 and, when activated, affects the preset programmes. Use the  $\wedge$  and  $\vee$  sensors to cycle through the two options and press 0K to confirm.

## **Service**

This setting should only be used by service personnel. No settings can be adjusted and this is purely for informative purposes. Use the  $\wedge$  and  $\vee$  sensors to cycle through the two options and press 0K to enter and the back sensor  $\lt$  to return.

## **Factory settings**

This feature can be used to restore the oven to the default settings. If you perform a setting adjustment in error and cannot rectify it, for example, you can use this feature. Press 0K and a confirmation message will appear. Press 0K again to confirm. If you do not wish to, press the back sensor  $\lt$  to return.

The default settings are:

- Language: English
- Backlight brightness: 80%/45%/30% (depending on activity)
- Backlight: ECO
- Oven: ECO
- Clock: 24hrs (current time should remain set)

# Electronic programmer/timer

This oven's timer is equipped with touch control sensors. Each registered touch of a sensor is confirmed by a beep. It is advisable to keep the sensors clean at all times to avoid errors in operation.

## Setting the current time

After connection to the mains supply, or re-connection after a power outage, the display will show 'Choose time format: 24hr'. Use the  $\wedge$  and  $\vee$  sensors to change between 24 and 12 hour time display. Press OK once the desired format is selected.





- Use the  $\wedge$  and  $\vee$  sensors to set the number of hours. Press OK.
- Use the  $\wedge$  and  $\vee$  sensors to set the time in minutes. Press OK.

## Please note:

- The time must be set for the oven to work.
- You can follow the above steps for changing the time. Firstly though, the oven must be on but not running a function and you must touch and hold the clock sensor  to enter time adjustment.

## Setting the minute minder function

The minute minder function can be set at any time whilst a function is active. The minute minder can be set anywhere from 1 minute to 23 hours and 59 minutes.

- Press the timer sensor . The  symbol on the display should flash and the time display should show '00:00'.
- Set the desired duration of the minute minder using the  $\wedge$  and  $\vee$  sensors. Touch the timer sensor  and the minute minder will be set. If a function is active, then you may have to cycle past the  $\rightarrow|$  and  $| \rightarrow$  symbols using the timer sensor .





- The  symbol will be solidly lit. The current time will be shown on the timer display.
- Press any of the sensors in order to deactivate the acoustic signal that sounds once the minute minder time has elapsed.

**Please note:** The acoustic signal, if not switched off manually, should deactivate automatically after approximately 1 minute.

### **Cancelling the minute minder function**



The minute minder function can be cancelled at any time.







- Press the timer sensor  until the  symbol is flashing. Then, use the  $\wedge$  and  $\vee$  sensors to return the minute minder time to '00:00'.

## **Semi-automatic cooking**

This function allows for a cooking time to be set. When the set time elapses, the oven will switch the set function off and an acoustic signal will sound to alert the user. The cooking time that can be set ranges from between 1 minute and 10 hours.

### **To switch on semi-automatic cooking**

- Set the desired oven function and temperature.
- Touch the timer  sensor until the  symbol flashes. The timer display should show '00:00'.
- Set the required cooking time using the  $\wedge$  and  $\vee$  sensors. The cooking time that can be set ranges from between 1 minute and 10 hours.

- Touch the timer  sensor to confirm and activate the function. You will then go to the delay timer section, denoted by the  symbol. Ignore this and press the timer  sensor again. Once active, the timer display will show the current time and the  symbol will be lit. The display next to the  symbol will show the time until cooking ends.
- At the end of the cooking duration, an acoustic signal will sound for approximately 1 minute, touch any sensor to cancel this. The timer display will flash '00:00' and the  symbol will flash.





### **To cancel semi-automatic cooking**

The semi-automatic function can be cancelled at any time. To do this, simply switch the oven off using the power sensor .









## **Automatic cooking**

This function allows for a duration and an end time to be set for cooking. With this, the oven will start cooking automatically due to the set duration determining how long before the end time that the function will activate and begin cooking. For example, if you set the cooking duration to 1 hour, and the end time to 15:30, then the oven will activate the function at 14:30. When the set time elapses, the oven will switch the set function off and an acoustic signal will sound.

### **To switch on automatic cooking**

- Set the desired oven function and temperature.
- Touch the timer  sensor until the  symbol flashes. The timer display should show '00:00'.
- Set the required cooking time using the  and  sensors. The

cooking time that can be set ranges from between 1 minute and 10 hours.

- Touch the timer  sensor to confirm and, with the  symbol flashing, set the time at which you'd like cooking to end/the oven to switch off using the  and  sensors. The end of cooking time can be set no more than 23 hours and 59 minutes ahead of the current time.
- Touch the timer  sensor and the automatic function will now be set. The display next to the  symbol will show the time at which the oven will turn on to begin cooking. Once cooking has begun, this display will show the remaining cooking time.
- Once the end of cooking time has been reached an acoustic signal will sound. '00:00', the  symbol and the  symbol will flash on the timer display. To deactivate the acoustic signal, press any of the sensors. Alternatively, the signal will deactivate automatically after approximately 1 minute.
- Switch the oven off to deactivate the function properly and stop the flashing symbols.

### **To cancel automatic cooking**

The automatic function can be cancelled at any time. To do this, simply switch the oven off using the power sensor .

**Please note:** It is not possible to adjust the time (of day) setting whilst the semi-automatic and automatic cooking functions are operational.

**Please note:** If you are using rapid preheating with automatic cooking, you must set the cooking and end times before pressing the rapid preheating sensor .

# Using the temperature probe

This oven comes with a temperature probe which allows you to cook food until it is a certain temperature inside. To use the temperature probe, simply follow the steps below:

- Insert the end marked 'O' (Fig. 3) into the oven probe socket, located on the top right side of the oven cavity (Fig. 2). Open the flap and push the probe in until it clicks and sits firmly and the probe indication  switches on on the display panel.



Fig. 2

- Insert the end marked 'T' (Fig. 3) into the food to be cooked.
- If you switch the oven, or a function, on with the temperature probe already plugged in you will be

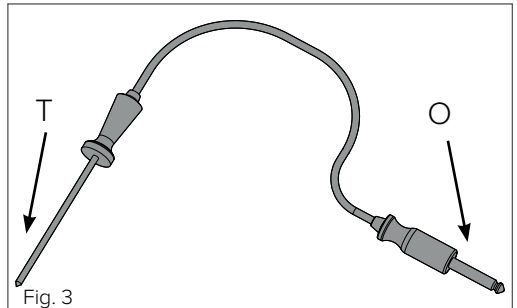





Fig. 3

prompted to enter the desired probe temperature first. If you plug the temperature probe in after activating a function, then you will be prompted to enter the desired temperature.

- You can still adjust the overall oven temperature by pressing the temperature sensor  until the temperature display next to the  symbol is flashing. Set the temperature using the  and  sensors and then press OK .

- Once the set probe temperature has been reached, the function will switch off. If you are using a programme with a duration (e.g. semi-automatic cooking) as well as the temperature probe, then the function will operate until the first condition to end the programme is met, i.e. until the probe temperature is reached or duration has elapsed.

Below are recommended temperatures depending upon the type of meat being cooked in conjunction with the temperature probe.

Type of meat	Ideal temperature °C
Pork	85 - 90
Beef	80 - 85
Veal	75 - 80
Lamb	80 - 85
Venison	80 - 85



**Please note:**

- You must only use the temperature probe approved for this oven.
- Always check that the food being cooked is done thoroughly before serving it to anyone.
- If you need to remove the temperature probe mid-function, ensure that you wear adequate PPE (Personal Protective Equipment) for the task (e.g. protect your hands, arms and face).
- Removing the temperature probe mid-function will cause the oven to go into an error state and stop the function.
- Some preset programmes require the temperature probe to be present or removed. Prompts will be displayed in cases such as these. You have approximately 1 minute to do as prompted before the oven cancels the selection.



# Safety key lock

The safety key lock is intended to help prevent accidental use or activation of the oven. Once locked, the oven should not respond to any controls except for the unlocking sequence. You can use the safety key lock feature when the oven is on, whilst most functions are active and whilst the oven is on standby.

## To activate the safety key lock

- Touch and hold the thermometer sensor  and the back sensor  for approximately 5 seconds. An acoustic signal should sound and the  symbol should illuminate to confirm that the lock is active.

## To deactivate the safety key lock

- Touch and hold the oven light sensor  and the back sensor  for approximately 5 seconds. An acoustic signal should sound and the  symbol should extinguish to confirm that the lock is now inactive.

# Eco mode

The eco mode is designed to reduce the overall energy consumption of the appliance. It does this by switching off elements 5 minutes before the end of cooking time and uses the residual heat within the oven cavity to cook for the remaining time. This mode is activated automatically with some functions and is indicated by the **ECO** symbol.

When the temperature probe function is used, the eco mode will switch off any elements approximately 2°C before the set temperature is reached. See page 15 for more information.

# Interior lighting

## The interior lighting should activate when:

- A function is activated (lasts approximately 30 seconds).
- Rapid preheating is complete (lasts approximately 30 seconds).
- The oven door is opened (it will remain on for approximately 10 minutes or until the door is closed.).
- You touch the oven light sensor  if the light is not already on (lasts approximately 30 seconds).

## The interior lighting should deactivate when:

- Automatically after 30 seconds if the door is closed or 10 minutes if the door is open.
- You touch the oven light sensor  if the light is not already off.

See page 14 on adjusting lighting settings.

## Active pause

Opening the door whilst any of the heating functions are active will cause said function to pause until the door is closed. If the door is open for longer than approximately 30 seconds, an alarm will sound to alert you. Touch any control or close the door to switch the alarm off.

**Remember** that the less you open the oven door during operation, the lower the energy consumption will be.

# Cleaning and maintenance

Keeping your oven clean and well maintained helps to prolong the fault-free lifespan of it. It is important that, before any cleaning or maintenance is performed, you switch off the oven at the mains supply. Do not start any cleaning or maintenance until the oven has been allowed to cool completely.

**We recommend always wearing PPE (Personal Protective Equipment) when carrying out any cleaning or maintenance.**

## Cleaning the oven exterior

As the oven has a stainless steel or enamel surface, you should use a nonabrasive cleaner. Any abrasive cleaner (including Cif) will scratch the surface and could erase the control panel markings. Stainless steel can be effectively cleaned by simply using a dilute solution of water and mild detergent and drying to a shine with a clean cloth.

Proprietary stainless steel cleaners are available. We recommend a microfibre cloth for stainless steel surfaces. If necessary, wipe any area that has been cleaned using a damp soft cloth or tissue to remove any residual cleaning fluid and then wipe dry with a clean, dry cloth or tissue (such as kitchen towel).

## Cleaning the oven interior

The oven should always be cleaned after use, or after a pyrolytic cleaning cycle, when it has been allowed to cool down.

The cavity should be cleaned using a mild detergent solution and warm water and then wiped dry with a suitable, clean cloth.



Suitable proprietary chemical cleaners may be used after first consulting with the manufacturers' recommendations and testing a sample on a small area of the oven cavity. Abrasive cleaning agents or scouring pads/cloths should not be used on the cavity surface.

### **IMPORTANT:**

- **Steam cleaners must not be used when cleaning this appliance. You can use the cleaning function (page 11).**
- **Once care and maintenance is complete, ensure that all parts are correctly replaced before using the oven.**

### **Removing the appliance door**

In order to allow for easier access into the oven cavity for cleaning, it is possible to remove the door. Before removing the door, ensure that you have an area prepared in which you can place the removed door. This area should ideally be protected by something like a folded, dirt-free, towel to help prevent damage to surfaces and the door.

- Open the door fully
- Tilt and lift the safety catch part of the hinge (fig. 4) so that it is fully lifted and points towards the door.
- Close the door most of the way, lift it slightly and then pull it, safely but firmly, towards you.



Fig. 4

## Replacing the appliance door

- Hold the door to the appliance in the closed position and manoeuvre the hinges so that the part of the hinge, highlighted in fig. 5, inserts into/hooks over the hinge slot in the cavity frame.
- Ensure the notch on the underside of the hinge sits on the lip of the hinge slot. Open the door fully. Each hinge should be seated in the same way as the hinge in fig. 5. If it is not, follow the steps for removing the door and try replacing it again.
- Finally, manoeuvre the safety catch part of the hinges back into place so that they are lying flat against the hinges (Fig. 6).



Fig. 5



Fig. 6

**Please note: If the hinge safety catches are not in the correct place then the door and/or appliance may receive damage when attempting to close the door.**

## Removing the inner door glass

With the door removed, the inner glass can also be taken out for cleaning purposes. Instructions are on page 27.

- Use a cross-headed screwdriver to undo the screws on either side of the upper door slat (Fig.7).
- Use a flat-headed screwdriver to remove the upper door slat by prying it gently at the sides (Fig. 7).
- Remove the door slat, as per fig. 8, and place it somewhere safe where it will neither receive nor cause damage.
- Remove the inner glass from the blocks it is seated within (near to the hinges) and place it somewhere safe also. Pay attention to the way that the glass is facing as it will need to be replaced in the same direction. The smooth surface of the glass should be facing upwards (inwards if the door was back in place) with the patterned side facing the oven door handle.
- Clean the door glass with warm, soapy water and wipe dry with a clean microfibre cloth.
- The middle panes of glass can also be removed but it is important that these panes are reinserted facing the same way that they were when removed.

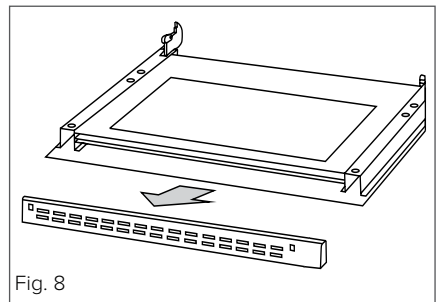
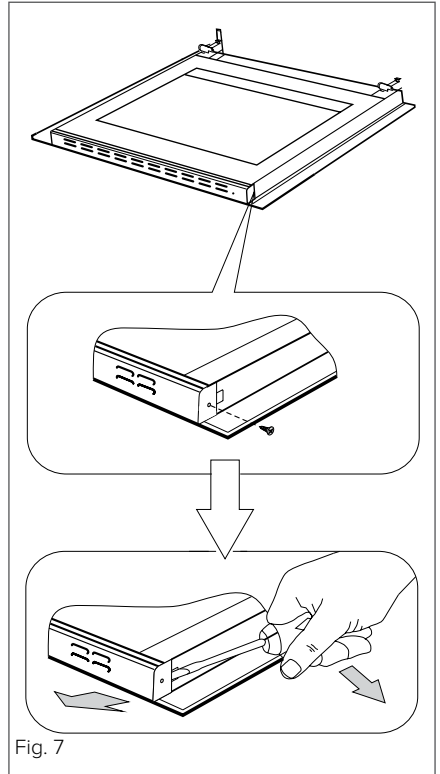

- There are a number of rubber guides attached to the inner panes and these must be returned to their original positions when reassembling the door. Fig. 9 shows one of these guides and the position on and around the inner glass.
- Simply reverse these steps in order to reassemble the door. Take care when reattaching the upper door slat. Place the left side on first until you hear a ‘click’ as it connects and then attach the right side. **This will help to avoid damaging the door and/or glass.**

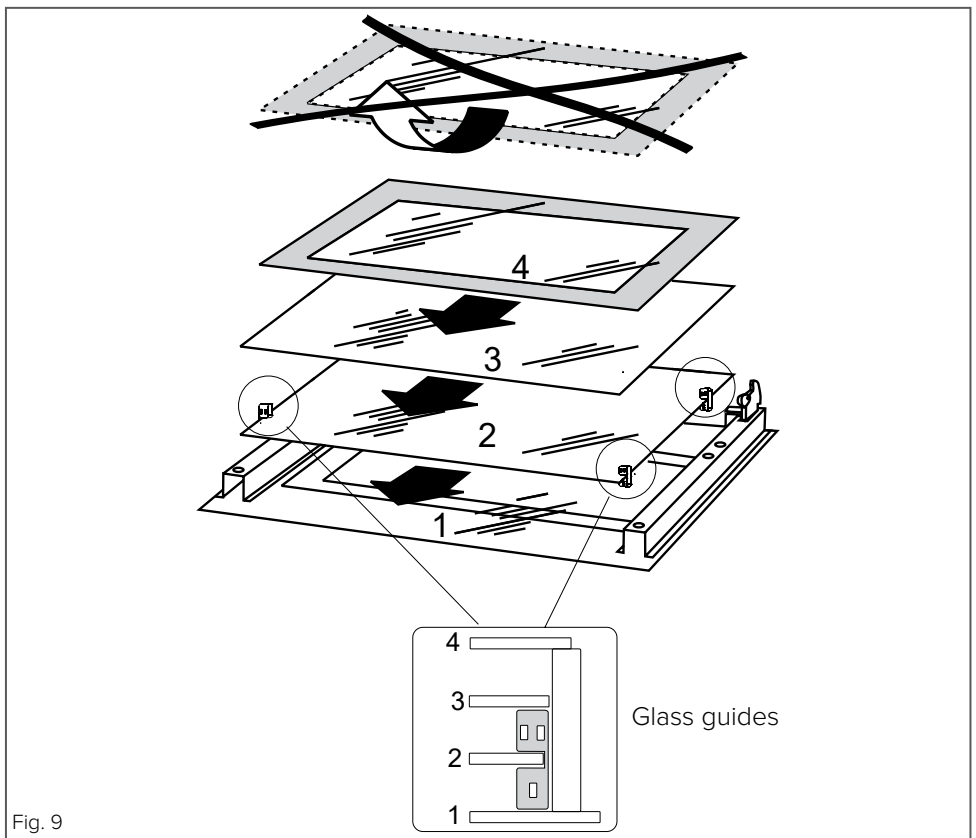

Fig. 9

**Important: Do not disassemble the door without it having been removed from the oven. Weight differences could cause the door to snap shut, causing damage to the oven and/or the user.**

## Removing the shelf supports

### Important:

**Always remember to allow the oven to cool sufficiently, if it has been in use, before carrying out any maintenance. You may find it easier to remove the telescopic runners first (page 30).**

### To remove the shelf supports

- Take a firm hold of the shelf support in the middle. Place your thumb against the oven wall and lever the support out of the support holes (Fig. 10)
- Tilt the shelf support outwards (Fig. 11) and you should then be able to remove the shelf support arms that secure it into the cavity walls at the back.

### To replace the shelf supports

- Simply carry out the above steps, but in reverse order.



### Please note:

Take care not to damage the enamel walls of the oven, particularly around the shelf support arm holes.

## Removing the telescopic runners

The oven's telescopic runners should be removed prior to the shelf supports. Take care as the runners can spring away from the supports suddenly. Please note when replacing the runners - the runners are marked with 'L' and 'R' on the inside to help you.

Removing the telescopic runners

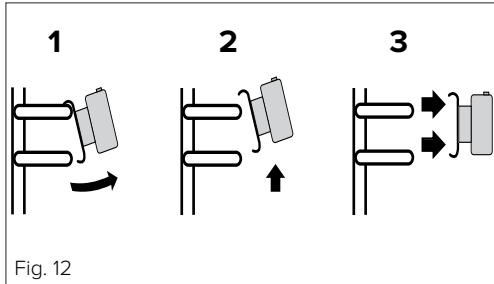

Replacing the telescopic runners

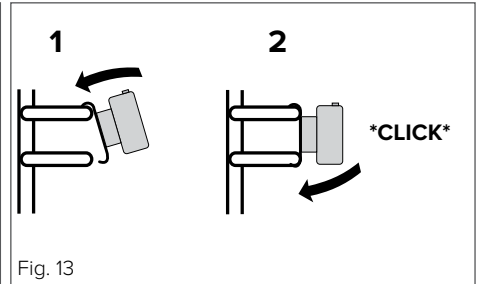

## Removing the catalytic liners

The oven's catalytic liners (if you are using them) can be removed for cleaning or replacement. Under normal use, the liners should keep themselves clean but stubborn or burnt on food/stains may mean they need to be cleaned or replaced. To aid the cleaning of them, you can run the oven on a heating function (such as fan) for 1 hour at 250°C.

Once the liners begin losing the ability to clean, they should be replaced. Remove the screw in the centre of the liner as per Fig. 14 and remove the liner.

When replacing the liner, do not over-tighten the screw as you could damage the liner and oven.

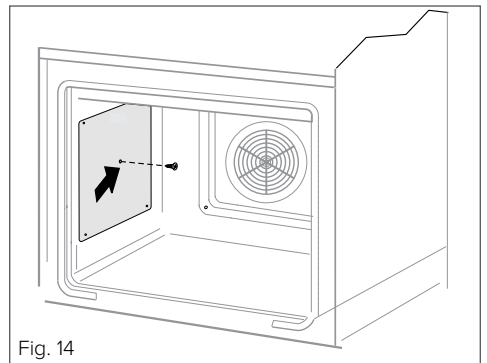

## Changing the oven light bulb(s)

### Important:

- **Before any maintenance is started involving electrical parts, the appliance must be disconnected from the power supply.**
- **If the oven has been in use, let the oven cavity and the heating elements cool down before attempting any maintenance.**
- **Please be careful when using utensils (e.g. flat-headed screwdriver) to remove the light cover. When not used carefully they could damage the enamel of the oven or the lamp holder.**
- **Never replace the bulb with bare hands as contamination from your fingers can cause premature failure. Always use a clean cloth or gloves. Old bulbs may also be hot!**

### Changing the bulb (fig. 15)

- Move any accessories that are blocking access to the bulb covers.
- Carefully, and with a small, clean, flat-headed screwdriver, pry the glass bulb cover(s) away from the side wall(s). Replace the bulb with the new one suitable for high temperatures (300°C) having the following specifications: 230-240V, 50Hz, 25W G9 fitting.
- Refit the protective cover. Ensure that the concave lip on the inside of the glass cover is at the top when refitting it (Fig. 15).



Fig. 15

**Please note:** The bulb replacement is not covered by your guarantee.

# Installation

**Important! If installing this oven below a hob, ensure that the air gap between the two appliances is observed. This gap is usually detailed in the hob's manual.**

**The installation of this appliance must be carried out by a suitably qualified person. We recommend seeking the help of another person for the installation process.**

If the oven is being installed into a built under oven housing unit ensure that the front rail at the top of the unit is not installed as it could restrict ventilation.

Ensure that air can flow freely around the housing area. If the oven is being installed into a fully enclosed built-under oven housing unit it may be necessary to cut a small slot in the top of the plinth fitted under the unit. Cut a section 400 mm

wide and a minimum of 15 mm high to allow air to pass under the unit. Alternatively cut a section 400 x 450 mm in the base of the carcass as indicated in Fig. 16.

Failure to allow adequate ventilation to the appliance may result in overheating or damage to adjacent units and could invalidate the warranty.

This appliance is type X installation.

The walls of the kitchen units must be able to withstand temperatures

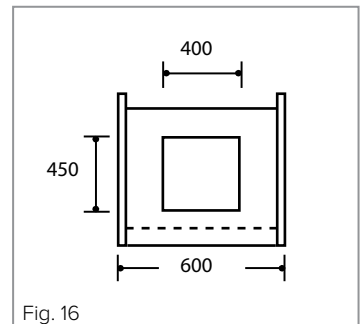

Fig. 16



of 100°C +.

When correctly installed ensure that there is a gap of 4 mm minimum between the sides of the oven and adjacent furniture doors.

## How to install your oven

**You will need the housing area in fig. 17 to fit your oven correctly.**

The oven is designed to fit into a cabinet of 600 mm width. The oven can be built in or built under the kitchen units, but you must ensure that it is properly ventilated. In the diagram below the built-in oven is ventilated by means of a space at the top of the kitchen cabinet. There are many other methods of ventilating your oven - consult a qualified engineer for advice.

Lift the oven carefully into position on the shelf, taking care NOT to lift it by the door handle. If you lower the oven door, you will see 4 screw holes, 2 on each side of the oven (image B fig. 17). The oven should then be secured to the housing by securing screws into these holes. Remember, the housing should not be free standing but be secured to the wall and/or adjacent fittings.

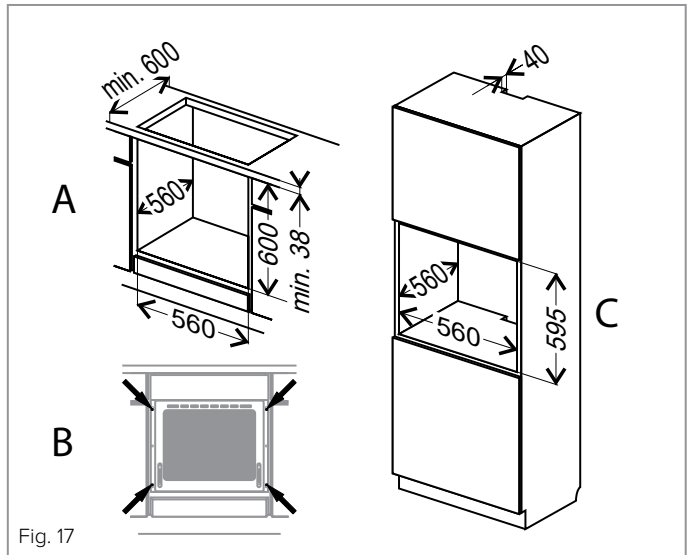

Fig. 17

## Adjusting the oven door

Whilst installing the oven, you may wish to adjust the final position of the door. The following allows for  $\pm 1.5\text{mm}$  adjustment:

- Loosen the nut (1) with a size 13 spanner.
- Use a size 4 allen key to rotate the spindle (2) in a  $180^\circ$  range.
- Once adjustment is complete, tighten the nut (1) whilst holding the allen key in place in the spindle (2).

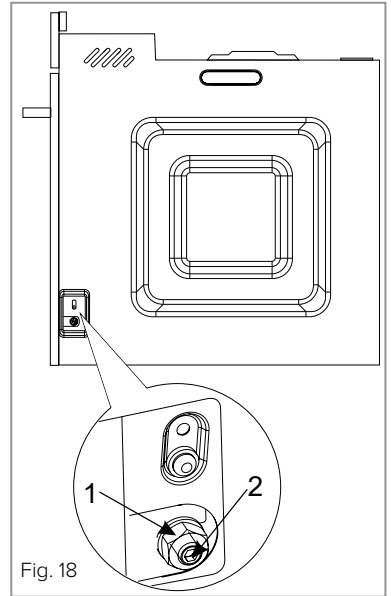

Fig. 18

## Mains electrical connection

**Warning! This appliance must be earthed.**

**This appliance is intended to be connected to fixed wiring by a double pole switch, having a contact separation of at least 3mm in all poles and protected by a 13A fuse. The switch must be positioned no further than 2m from the appliance.**

We recommend that the appliance is connected by a qualified electrician, who is a member of the N.I.C.E.I.C. and who will comply with the I.E.T and local regulations. The wires in the mains lead are coloured in accordance with the following code:

**GREEN AND YELLOW = EARTH, BLUE = NEUTRAL, BROWN = LIVE.**

As the colours of the wires in the mains lead for the appliance may not correspond with the coloured markings identifying the terminals in your spur box, proceed as follows:

1. The wire which is coloured green and yellow must be connected to the terminal marked E (Earth) or coloured Green.
2. The wire which is coloured blue must be connected to the terminal marked N (Neutral) or coloured Black.
3. The wire which is coloured brown must be connected to the terminal marked L (Live) or coloured Red.

**Please note:**

- The mains cable must only be replaced by a qualified electrician or service engineer and must be of equivalent or better rating (i.e. 3 x 1.5 mm<sup>2</sup>, HO5VV-F).
- This appliance is intended to be connected to the mains supply with a cable of cross sectional area 1.5 mm<sup>2</sup>.
- The current rating of the fuse or circuit breaker protecting this appliance should be marked on the socket outlet.
- Assembly and electrical connection should be carried out by specialised personnel.
- When installing this product we recommend you seek the help of another individual.
- Should the mains cable be damaged or need to be replaced, it should only be done so by a qualified electrician or engineer. The terminal block on the appliance is clearly marked with regards to the positions of live, neutral and earth.

Appliance electrical rating: 2800W

# Troubleshooting

Problem	Reason	Remedy
1. The appliance does not work	No power	Check the power supply and the fuse, replace if blown.
2. Oven lighting does not work.	Loose or damaged bulb	Replace the blown bulb (see Cleaning and Maintenance on page 24).
3. E0 error	Oven temperature reading error	You cannot use the oven, please refer the repair to the nearest service centre.
4. E1 error	Probe temperature reading error	The message should disappear once the probe is unplugged. Oven can still be used without meat probe. Replace the probe.
5. Fan does not work	Risk of overheating! Immediately unplug the appliance or switch off the main circuit breaker. Refer the repairs to the nearest service centre.	
6. Oven has power but is not heating	Ensure the clock has been set (see page 16). Automatic cooking may be set (see page 18).	

If any of the above steps do not resolve your issue, please contact CDA Customer Care to arrange a repair. Contact details are below. Please have to hand all the details from your appliance's rating plate which can be found on the back of the oven and/or on the back of the instruction manual/warranty card.

**Important:** All repairs must be carried out by CDA authorised service technicians.

## Contact CDA Customer Care

**A:** Customer Care Department, The CDA Group Ltd, Harby Road,  
Langar, Nottinghamshire, NG13 9HY

**T:** 01949 862 012

**F:** 01949 862 003

**E:** [customer.care@cda.eu](mailto:customer.care@cda.eu) **W:** [www.cda.eu](http://www.cda.eu)

## Energy Efficiency Information

Attribute	Symbol	Value	Units
Model identification		SK900	
Mass of the appliance	M	36.6	kg
Energy efficiency index (EEI cavity)		81.7	
Energy efficiency class		A+	
Number of cavities		1	
Heat source per cavity (electricity or gas)		Electricity	
Volume per cavity	V	65	L
Energy consumption (electricity) required to heat a standardised load in a cavity of an electric heated oven during a cycle in conventional mode per cavity (electric final energy)	$EC_{\text{Electric cavity}}$	0.99	kWh/cycle
Energy consumption (electricity) required to heat a standardised load in a cavity of an electric heated oven during a cycle in fan-forced mode per cavity (electric final energy)	$EC_{\text{Electric cavity}}$	0.67	kWh/cycle
Energy consumption required to heat a standardised load in a gas-fired cavity of an oven during a cycle in conventional mode per cavity (gas final energy)	$EC_{\text{Gas cavity}}$	N/A	MJ/cycle : kWh/cycle
Energy consumption required to heat a standardised load in a gas-fired cavity of an oven during a cycle in fan-forced mode per cavity (gas final energy)	$EC_{\text{Gas cavity}}$	N/A	MJ/cycle : kWh/cycle

E & O E. All instructions, dimensions and illustrations are provided for guidance only. CDA reserve the right to change specifications without prior notice.



**For service or queries relating to your product please contact:**

The Customer Care Department on **01949 862 012** or email [customer.care@cda.eu](mailto:customer.care@cda.eu)

**For more information please contact:**

The Sales Department on **01949 862 010** or email [sales@cda.eu](mailto:sales@cda.eu)

**Customer Care Department.** The CDA Group Ltd, Harby Road, Langar, Nottinghamshire, NG13 9HY  
T: 01949 862 012 F: 01949 862 003 E: [customer.care@cda.eu](mailto:customer.care@cda.eu)